



**OR**

**OPERATING  
RULES**

**EFFECTIVE JANUARY 1, 2015**

# **NORFOLK SOUTHERN CORPORATION**

These rules govern operations on the railroad subsidiaries of Norfolk Southern Corporation. On the effective date, these rules supersede all previous rules and instructions.

Further instructions may be issued by proper authority.

**MARK D. MANION**

Executive Vice President and Chief Operating Officer

**EFFECTIVE:  
JANUARY 1, 2015**

---

# OPERATING RULES

---

THIS BOOK IS THE PROPERTY OF  
**NORFOLK SOUTHERN**  
AND ITS RAILROAD SUBSIDIARIES  
ISSUED TO

---

**NAME**

**EMPLOYED AS**

---

---

---

---

---

---

who must return it to the proper officer when called for,  
or when leaving the service.

This page is intentionally left blank.

# TABLE OF CONTENTS

<b>GENERAL NOTICE .....</b>	<b>1</b>
<b>GENERAL RULES .....</b>	<b>2</b>
A. Standard Time.....	2
B. Watch Requirement.....	2
C. Rules, Bulletins, and Special Instructions.....	2
D. Notification.....	3
E. Operations Bulletins.....	3
F. Documentation.....	3
G. Drugs and Alcohol.....	4
H. Terms for Crewmembers.....	5
I. Reporting Non-Compliance.....	5
J. Reporting Unusual Occurrences.....	5
<b><i>Certification and Qualification</i></b>	
K. Required Certification.....	6
L. Required Examinations.....	6
M. Qualifications.....	6
N. Conductors, Locomotive Engineers, and Employees Seeking Initial Certification.....	8
O. Acting as Pilot.....	8
P. Dispatcher Qualification.....	8
Q. RWIC and Equipment Operator Qualification.....	9
R. Tampering and Unauthorized Devices.....	9
S. Riding Locomotives and Freight Trains.....	10
<b>ATTENTION TO DUTY .....</b>	<b>11</b>
1. Job Safety Briefings.....	11
2. Prohibited Activities.....	12
3. Napping.....	13
4. Performing Duties Safely.....	14
5. Electronic Devices.....	14
<b>SAFETY CRITICAL RULES.....</b>	<b>17</b>
20. Prohibited Acts.....	17
21. Fouling a Track.....	19
22. Fouling Equipment.....	20
23. Single Engineer Procedures for Fouling Equipment.....	22
24. Protection in Bowl (Classification) Tracks.....	23
25. Occupying Roofs of Freight Cars.....	24
26. Riding Side of Equipment.....	24
27. Close Clearance.....	24
<b>COMMUNICATION .....</b>	<b>25</b>
<b><i>General Requirements</i></b>	
30. Communication Equipment Requirements – Trains.....	25
31. Communication Equipment Requirements – Maintenance of Way Equipment.....	25
32. Communication Equipment Requirements – Maintenance of Way Work Gangs.....	25
33. Communication Equipment Requirements – Roadway Worker in Charge.....	25

# TABLE OF CONTENTS (continued)

34.	Communication Equipment Requirements – Lone Worker .....	25
35.	Communication Equipment Requirements – Exceptions .....	26
36.	General Instructions for the Use of Radios .....	26
37.	Radio Use .....	26
38.	Radio Channels .....	26
39.	Radio Transmission Restrictions .....	26
40.	Equipment Responsibilities .....	26
41.	Taxi and Relief Crews – Communication .....	27
42.	Federal Communications Commission (FCC) Requirements .....	27
	<b><i>Radio Failure, Testing, and Emergencies</i></b>	
45.	Radio Voice Test .....	28
46.	Malfunctioning Radios .....	28
47.	Radio Removed From Service .....	28
48.	Locomotive Radio Failure .....	28
49.	Reporting Emergencies by Radio .....	28
50.	Radio – Field Emergency Situations .....	29
	<b><i>Radio Communication</i></b>	
51.	Initiating a Radio Transmission .....	30
52.	Identifying a Radio Transmission .....	30
53.	Identifying a Mobile Station .....	30
54.	Achieving Positive Radio Identification .....	30
55.	Continuous Positive Radio Identification .....	31
56.	Verification of Radio Contact .....	31
57.	Acknowledging Receipt of a Transmission .....	31
58.	Repeating Transmissions .....	31
59.	Ending a Transmission – Response Expected .....	31
60.	Ending a Transmission – Response Not Expected .....	31
	<b>SIGNALING EQUIPMENT .....</b>	<b>32</b>
65.	Equipment .....	32
66.	Care and Use .....	32
67.	Fusees .....	32
	<b><i>Hand Signals</i></b>	
68.	Hand Signals .....	33
69.	Giving and Receiving Hand Signals .....	33
	<b><i>Locomotive Horns</i></b>	
70.	Locomotive Horn Signals .....	34
71.	Locomotive Horn Failure .....	35
	<b><i>Locomotive Bells and Lights</i></b>	
72.	Engine Bell .....	36
73.	Locomotive Headlights .....	36
74.	Auxiliary Lights .....	37
75.	Operative Auxiliary Lights .....	37
76.	Operational Auxiliary Lights .....	37
77.	One Pair of Auxiliary Lights Fail En Route .....	37
78.	All Auxiliary Lights Fail En Route .....	37

# TABLE OF CONTENTS (continued)

79.	Auxiliary Lights When Employees are Mounting.....	37
80.	Situations to Turn Off Auxiliary Lights .....	37
	<b>End of Train Markers</b>	
81.	Requirements for Markers.....	38
82.	Flashing Electric Markers.....	38
83.	Red Reflectorized Disc or Red Flag Marker.....	38
84.	Marker Examination Requirements .....	38
85.	Marker for Light Engine or Engine on the Rear of a Train.....	39
	<b>MOVEMENT OF TRAINS AND ENGINES.....</b>	<b>40</b>
	<b>Yard Limits – Main Track</b>	
93.	Main Track Within Yard Limits.....	40
	<b>General</b>	
94.	Responsibility for Safety of the Train.....	41
95.	Starting.....	41
96.	Return Movement.....	41
97.	Movement of Single Light Locomotive.....	41
98.	Helper Service.....	42
99.	Precautions against Unusual Conditions.....	42
100.	Approaching the End of Two or More Tracks, Railroad Crossings At Grade, and Drawbridges.....	43
101.	Protection against Following Trains.....	43
102.	Permanent Signs.....	43
103.	Safe Movement of Trains and Engines – Slow Order Conditions.....	44
104.	Restricted Equipment.....	45
105.	Stopping on Bridges.....	45
	<b>Emergency Brake Applications</b>	
110.	Emergency Brake Application – Warning to Approaching Trains On Adjacent Tracks.....	46
111.	Trains on Adjacent Tracks.....	46
112.	Responsibility of the Train Dispatcher after an Emergency Brake Application.....	46
113.	Train Inspection after an Emergency Brake Application.....	46
	<b>Reverse Movements on Controlled Track</b>	
115.	Reverse Movements on Controlled Track.....	48
116.	Train Dispatcher Authorizing Reverse Movements.....	48
	<b>Movements over Highway – Rail Grade Crossings</b>	
120.	Cars not Headed by an Occupied Engine over a Highway – Rail Grade Crossing.....	50
121.	Clearing Crossings.....	51
122.	Adjacent Tracks at Crossings.....	51
123.	Approaching Crossings with Automatic Warning Devices.....	51
124.	Manually Raising Crossing Gate Arms.....	52
125.	Highway – Rail Grade Crossing Warning System Malfunction.....	52
126.	Activation Failure.....	53
127.	False / Partial Activation.....	53

# TABLE OF CONTENTS (continued)

128. Traffic at Crossings.....	54
129. Near Miss.....	54
<b><i>Train Inspections</i></b>	
140. Inspecting Trains.....	55
141. Equipment with Defects.....	55
142. Setting off Cars on Line-of-Road.....	56
<b><i>Defective Equipment Detectors</i></b>	
145. Defective Equipment Detectors.....	57
146. Train Inspection – “No Defect” Message.....	58
147. Train Inspection – Defect Message.....	58
148. Hotbox Detectors.....	59
149. Hot Wheel Detectors.....	60
150. Dragging Equipment Detectors.....	60
151. High Car and Clearance Detectors.....	60
152. Failure Message Received.....	61
153. No Message Received.....	61
154. Conditions When a Visual Inspection is Not Required.....	62
155. Consecutive Detector Stops.....	62
156. Stress State Detectors.....	62
<b><i>Non-Signaled Main Track</i></b>	
171. Non-Signaled Main Track – Mandatory Directive Authorizes Movement.....	67
172. Communicating Station Names.....	67
<b><i>Train Meets and Passes</i></b>	
174. Positive ID at Meeting or Passing Points.....	68
175. Switches at Meeting Points.....	68
176. Engineer Requirements at Meeting Points.....	68
177. Responsibility for Authorized Limits.....	68
178. Conductor’s Responsibility – Approaching Slow Orders and Conditional Stop Signs.....	69
179. Communicating Speed of Slow Orders.....	69
180. Acknowledging Slow Order Information In-Cab.....	69
<b>HANDLING SWITCHES AND DERAILS.....70</b>	
181. Responsibilities; Hand Operated Switches and Derails.....	70
182. Operating Switches by Hand.....	70
183. Hand Operated Switches Equipped with Electric Locks.....	70
184. Engineering Department Operating Switches.....	70
185. Double Checking Switch or Derail Position.....	71
186. Lining and Locking Switches and Derails after Use.....	71
187. Operating Over a Switch.....	71
188. Fouling or Entering a Track.....	72
189. Switches – Line of Road and Industry Tracks.....	72
<b><i>Main Track, Dual Control, and Power Switches</i></b>	
190. Position of Main Track and Siding Switches.....	73
191. Lining Main Track Switch – Employee Position.....	73
192. Dual Control Switches.....	73



# TABLE OF CONTENTS (continued)

193. Power-Operated Switches.....	74	
194. Authority to Enter Main Track at a Hand-Operated Switch.....	74	
195. Operation of Hand Throw Mainline Switches.....	75	
<b>Main Track Switch Position</b>		
197. Switch Position Confirmation.....	76	
198. Leaving a Main Track Switch Open.....	76	
199. Reporting Clear of Main Track.....	76	
200. Clearing Main Track.....	76	
201. Clearing Main Track at Hand-Throw Switch.....	76	
202. Switch Position Awareness: Requirements for Hand-Operated Main Track Switches in Non-Signaled Territory and Rule 251 "Track Signaled in One Direction".....	77	
<b>Crossovers</b>		
203. Crossover Switches.....	79	
204. Crossover Switch Alignment.....	79	
205. Crossover Switches in Correspondence.....	79	
206. Corresponding Position.....	79	
<b>Spring Switches</b>		
207. Spring Switches.....	80	
208. Stopped on Spring Switches.....	80	
209. Operating Spring Switches by Hand.....	80	
210. Restoring Spring Switches.....	80	
211. Spring Switch Marker Lights.....	80	
<b>Derails</b>		
212. Derails: Location & Position.....	82	
213. Permanent Blue Signal Derails.....	82	
<b>SHOVE MOVEMENTS.....</b>		<b>83</b>
215. Shoving Equipment at Any Location.....	83	
216. Shoving, Backing, or Pushing Movements.....	84	
217. Operating a Train from Other than Leading End.....	85	
<b>Shove Lights</b>		
218. Shove Lights – Job Briefing.....	86	
219. Shove Lights – Shove Movement.....	86	
220. Yardmaster Responsibility – Shove Lights.....	87	
221. Mechanical Department Responsibility – Shove Lights.....	87	
<b>SWITCHING OPERATIONS.....</b>		<b>88</b>
<b>Leaving Equipment in the Clear</b>		
223. Equipment Left Standing.....	88	
<b>Securing Equipment</b>		
224. Hand Brakes.....	89	
225. Hand Brake Requirements.....	89	
226. Testing Hand Brakes.....	89	
227. Securement of Key Trains.....	89	
228. Securement of Equipment.....	91	

# TABLE OF CONTENTS (continued)

## **General Switching Requirements**

229. Switching Operations.....	92
230. Proper Understanding between Crews When Switching.....	92
231. Running or Flying Switches or Dropping Cars.....	92
232. Switching Near Passenger Stations.....	93
233. Passenger Equipment, Camp Cars, Caboose, and Wheel Cars.....	93
234. Protection of Rail Equipment.....	94
235. Wheel Chocks.....	94
236. On Curves or In Switches.....	94
237. Mismatched Couplers.....	94
238. Cars Being Loaded or Unloaded.....	94
239. Open Doors on Equipment.....	95
<b>SIGNAL ASPECTS AND INDICATIONS.....</b>	<b>96</b>

## **Communicating Signal Indications**

240. Responsibilities; Movement of Trains and Engines on Signal Indication.....	96
241. Communicating Block and Interlocking Signals.....	96
242. Conductor Communicating Signals.....	96
243. Crewmembers on Trailing Units Communicating Signals.....	97
244. Communicating Change in Cab Signal Aspect.....	97
245. Signal Indication Information.....	97

## **Signaled Main Track**

250. Tracks Designated in the Timetable.....	98
251. Track Signaled in One Direction – Signals Authorize.....	98
252. Movements against the Current of Traffic – Rule 251 “Track Signaled in One Direction” Territory.....	98
261. Track Signaled in Both Directions – Signals Authorize Movements.....	99
271. Track Signaled in Both Directions – Mandatory Directive Authorizes Movement.....	99

## **Train Movement in Signaled Territory**

272. Lining Route and Clearing Signals.....	100
273. Signals Requiring a Stop.....	100
274. Stop Obstruction Banners.....	100
275. Stopped at a Stop Signal.....	100
276. Passing a Stop Signal with Proper Authority.....	101
277. Authorization to Pass a Stop Signal.....	102
278. Violating a Stop Signal.....	103
279. Entering Controlled Track between Signals.....	103
280. Train Delayed in Approach to Automatic Interlocking.....	103
281. Delayed / Stopped in a Block.....	104
282. Movements Stopped Near Controlled Signals.....	104
283. Next Signal Governing.....	104
284. Moving from Signaled to Non-Signaled Controlled Track.....	105
285. Beginning and Ending of ABS Territory.....	105
286. Automatic Block Signal Used in Non-ABS Territory.....	105
287. Unexpected Signal Changes.....	105

# TABLE OF CONTENTS (continued)

288. Absent or Imperfectly Displayed Aspects or Erratic Signals.....	106
289. Improper Signal.....	106
<b>Signal Failure and Repair</b>	
290. Shunting – Track.....	107
291. Testing Signals.....	107
292. Rusty Rail.....	108
293. Track Occupancy Lights.....	108
294. Track Lights Left Behind Trains.....	109
295. Signal and Switch Malfunction.....	110
296. Suspension of the Signal System.....	110
297. Movement Authority during Suspension of the Signal System.....	111
298. Operating Instructions during Suspension of the Signal System.....	111
299. Lining Signals in the Field during Code Fail.....	111
<b>Signal Requirements</b>	
300. General Requirements; Qualifying Features.....	114
301. Location of Signals.....	114
302. Number Plates.....	115
305 – 325. Signal Aspects and Indications – Conrail Signals.....	117
326 – 339. Signal Aspects and Indications – Norfolk and Western Signals.....	129
340 – 354. Signal Aspects and Indications – Norfolk Southern Railway Signals.....	139
<b>CAB SIGNAL SYSTEM.....</b>	
355. Cab Signal Aspects.....	147
356. Train Not Equipped with Cab Signal Apparatus.....	148
357. Testing Cab Signal Apparatus.....	149
358. Conformity between Cab Signals and Fixed Signals.....	150
359. Cab Signal Changes between Fixed Signals.....	151
360. Movement with Inoperative Cab Signals.....	152
361. Criteria for Determining Cab Signal Apparatus Failure.....	152
362. Train Dispatcher’s Authorizations for Movement.....	153
363. Train Dispatcher’s Responsibility for Recording Movements.....	153
364. Cab Signal Aspect Flips.....	154
365. Engineer’s Responsibility to Report on Forms.....	154
366. Circumstances in Which Cab Signal Gives no Indication.....	154
367. Cab Signal Portion of Wayside Signaling Equipment Not Operative.....	154
368. Movements in Territory Where Cab Signals are Used without Fixed Automatic Block Signals.....	155
369. Authorization for Movement in Rule 368 Territory.....	157
<b>MANDATORY DIRECTIVES.....</b>	
500. Initiating a Mandatory Directive.....	158
501. Receiving a Mandatory Directive.....	158
502. Copying a Mandatory Directive.....	158
503. Transmitting a Mandatory Directive.....	158
504. Repeating a Mandatory Directive.....	159
505. Acknowledging a Mandatory Directive.....	159
506. Acting upon a Mandatory Directive.....	160
507. Voiding a Mandatory Directive.....	160

# TABLE OF CONTENTS (continued)

## ***Exclusive Authority***

510. Exclusive Track Occupancy (ETO).....	161
511. Exclusive Authority – Controlled Track.....	161
512. Precautions Issuing Authorities.....	161
513. Protecting Exclusive Authority.....	161

## ***Giving and Receiving Authority***

520. Requesting Authority.....	162
521. Authority Form.....	162
522. Mandatory Directive Authority Form.....	162
523. Designation of Trains.....	162
524. Designated Limits.....	162
525. Movement Authority.....	163
526. “Other Specific Instructions”.....	163
527. Transmitting Contents of an Authority Form.....	164
529. Receiving a Track Authority.....	164
530. Verifying a Track Authority.....	164
531. Giving “OK” Time.....	164
532. Conductor Not on Controlling Unit.....	164
533. Relaying Track Authority Information.....	165
534. “OK”.....	165
535. Electronic Transmission.....	165

## ***Authorities Restricting Movement***

540. Issuing Authorities Restricting Movement.....	166
541. Confirmation of Authorities Restricting Movement.....	166
542. Conditional Reminders of Authorities Restricting Movement.....	166
543. Conditional Track Authorities – Rule 171 Territory.....	166

## ***Joint, Overlapping, and Subdivided Limits***

550. Occupying Same Limits.....	167
551. Protecting Joint or Overlapping Limits of Trains.....	167
552. Authorizing a Joint Track Authority.....	167
553. Clearing a Joint Track Authority.....	168
554. Subdividing Limits.....	168

## ***Authorities Protecting Roadway Workers or On-Track Equipment***

560. Protecting Roadway Workers or On-Track Equipment.....	169
561. Protecting Joint or Overlapping Limits – Roadway Workers or On-Track Equipment.....	169
562. Requirements for Issuing Overlapping Limits to Roadway Workers or On-Track Equipment.....	169
563. Roadway Workers & Operators of On-Track Equipment – Do Not Foul Limits Ahead Of”.....	170

## ***Clearing Authorities***

570. Expiration Time.....	171
571. Expiration of Authority.....	171
572. Relieved During Tour.....	171
573. Reporting Clear.....	171
574. Clearing Authorized Limits.....	172
575. Dispatcher Clearing Authority.....	172
576. OS’ing (Reporting Passed).....	172
577. Voiding a Track Authority.....	173

# TABLE OF CONTENTS (continued)

<b><i>Improper Handling of Track Authorities</i></b>	
580. Improper Entries Discovered.....	174
581. Filling out Forms in Advance.....	174
<b>WEATHER PRECAUTIONS.....</b>	<b>175</b>
590. Flash Flood Warning.....	175
591. High Wind Alerts.....	176
<b>EMPLOYEE RESPONSIBILITIES.....</b>	<b>177</b>
<b><i>Yardmaster</i></b>	
600. Authority and Responsibilities; Yardmasters.....	177
<b><i>Train Service Employees</i></b>	
610. Conductors – Authority and Responsibilities.....	178
612. Seating.....	178
<b><i>Engine Service Employees</i></b>	
620. Responsibilities; Engine Service Employees.....	179
621. Operating an Engine.....	179
622. Leaving the Engine Cab.....	179
623. Use Caution; Exercise Care.....	179
624. Use of Sand.....	179
<b><i>Train Dispatchers</i></b>	
630. Responsibilities; Train Dispatchers.....	180
631. Presence on Duty; Relief.....	180
632. Transfer Record.....	180
633. Blocking Devices.....	181
<b>BLUE SIGNAL PROTECTION.....</b>	<b>182</b>
<b><i>General Blue Signal Requirements</i></b>	
650. Blue Signal Protection.....	182
651. Display of Blue Signals.....	182
652. Emergency Repair Work.....	182
653. Blue Signals Protecting Equipment.....	183
654. Blue Signals on a Controlling Unit.....	183
655. Entering an Engine Service Track.....	183
656. Moving Units on Engine Service Track.....	183
657. Authority to Move Units on Engine Service Track.....	183
658. Blue Signal on Main Track.....	183
659. Blue Signal on a Remotely Controlled Switch.....	183
660. Blue Signal on Other Than Main Track.....	184
661. Blue Signals on Industry Tracks.....	186
662. Protection Required in Connection with End-Of-Train Devices or Markers.....	186
663. Rolling Equipment under Blue Signal Protection.....	186
<b><i>Utility Employees</i></b>	
670. Utility Employees.....	187

# TABLE OF CONTENTS (continued)

<b>ROADWAY WORKER PROTECTION</b> .....	<b>189</b>
<b><i>Establishing Roadway Worker Protection</i></b>	
700. Roadway Worker Responsibilities.....	189
701. Roadway Worker Job Briefing.....	189
702. Roadway Worker Duties.....	189
703. Understanding Before Roadway Workers Foul a Track.....	190
704. Understanding Before a Lone Worker Fouls a Track.....	190
705. Roadway Worker Visibility.....	190
<b><i>Establishing Working Limits</i></b>	
710. On-Track Procedures for Roadway Work Groups.....	192
711. Roadway Workers Fouling a Track.....	192
712. Work That May Shunt Track Circuits.....	192
<b><i>Exclusive Track Occupancy for Roadway Workers</i></b>	
720. Exclusive Track Occupancy.....	193
721. Establishing Extent of Exclusive Track Occupancy Limits.....	193
<b><i>Conditional Stop Signs</i></b>	
725. Conditional Stop Signs – Working Limits.....	195
726. Conditional Stop Signs Job Briefing.....	195
727. Conditional Stop Sign Bulletin Item.....	195
728. Use of Approach Signs.....	195
729. Use of Conditional Stop Sign.....	196
730. Placement of Conditional Stop Signs.....	196
731. Authorization to pass a Conditional Stop Sign.....	196
732. Entering into Form Y Working Limits.....	197
733. Reverse Direction or Reverse Movement While Within Form Y Working Limits.....	197
734. Conditional Stop Sign Located at a Point or Time Not Designated by Form Y.....	197
735. Conditional Stop Sign Not Located at a Point or Time Designated by Form Y.....	197
736. Form Y.....	198
737. Junctions and/or Switches Located within Working Limits or Between the Approach Sign and Conditional Stop Sign.....	198
<b><i>Train Coordination</i></b>	
740. Train Coordination.....	200
741. Establishing Working Limits by Train Coordination.....	200
742. Train Coordination Communication.....	200
743. Recording Train Coordination Working Limits.....	201
<b><i>Inaccessible Track</i></b>	
745. Inaccessible Track.....	202
746. Working Limits of Inaccessible Track.....	202
747. Switch or Deraill Tags.....	203
<b><i>Working Limits</i></b>	
751. Control of Working Limits.....	204
752. Movements of Trains and Engines Within Working Limits.....	204
753. Notification Before Releasing Working Limits.....	204
754. Working Limits on Controlled Track.....	204
755. Working Limits on Non-Controlled Track.....	204

# TABLE OF CONTENTS (continued)

<b><i>Train Approach Warning Provided by Watchmen / Lookouts</i></b>	
756. Train Approach Warning Provided by Watchmen / Lookouts.....	205
757. Train Approach Warning Notification and Attention.....	205
758. Watchman / Lookout Equipment.....	205
759. Employee Positioning and Communication when Using Train Approach Warning.....	206
<b><i>Adjacent Controlled Track</i></b>	
760. Adjacent Controlled Track.....	207
761. Movement on Adjacent Controlled Track.....	207
762. Resuming Work.....	208
763. Exceptions to On-Track Safety for Adjacent Controlled Tracks.....	208
764. Roadway Maintenance Machines Fouling Adjacent Tracks.....	210
765. Adjacent Controlled Track “Job Briefing”.....	210
<b><i>Individual Train Detection</i></b>	
780. On-Track Safety Procedures for Lone Workers.....	211
781. Individual Train Detection Selection.....	211
782. Use of Individual Train Detection.....	211
783. Individual Train Detection Place of Safety.....	212
784. Lone Worker Positioning.....	212
785. Recording Individual Train Detection.....	212
<b>USE AND OPERATION OF ON-TRACK EQUIPMENT.....213</b>	
800. Responsibilities; On-Track Equipment.....	213
801. Use of On-Track Equipment.....	213
802. Equipment Inspection.....	213
803. Flagging Equipment.....	213
804. Protecting Work Locations.....	214
805. Protection on Controlled Track.....	214
806. Joint Occupancy of Working Limits.....	215
807. Movement in Yard Limits and Rule 251 Territory.....	216
808. Non-Interlocked Railroad Crossing at Grade.....	216
809. Insulated On-Track Equipment.....	217
810. Non-Insulated On-Track Equipment.....	217
811. Fouling a Railroad Crossing at Grade.....	217
812. Speed of On-Track Equipment.....	217
813. Highway Grade Crossings; Warning Devices.....	217
814. Operating with Caution.....	218
815. Vigilant Lookout; Conduct.....	218
816. Shunting.....	218
817. Moving Against the Current of Traffic.....	218
818. Proper Spacing Between Rail Equipment.....	218
819. Securing On-Track Equipment.....	219
820. Operation at Night.....	219
821. Approaching Trains.....	219
822. Drawbridges.....	219
823. Riding Equipment; Adjustments.....	219
824. Repairs to Equipment.....	220
825. Rail Sweeps.....	220
826. Pushing, Towing, Coupling Equipment.....	220
827. Fuel Tanks; Open Flames; Cooling Systems.....	220

# TABLE OF CONTENTS (continued)

828. Switch-Derail Position.....	221	
829. Operation of FRA Track Geometry Car, Sperry Rail Test Cars, and Rail Grinders.....	221	
<b>Camp Cars</b>		
840. Protection of Occupied Camp Cars.....	223	
841. Restrictions.....	223	
842. Responsibilities of Camp Car Occupant/Supervisor.....	223	
843. When Camp Cars are to be Moved.....	224	
844. Responsibilities of Employees Controlling Remotely Controlled Switches .....	224	
<b>REMOTE CONTROL LOCOMOTIVES.....226</b>		
850. Remote Control Guidelines.....	226	
851. Setup and Testing.....	227	
852. Securing Equipment .....	228	
853. Remote Control Areas.....	228	
854. Remote Control Zones.....	228	
855. Daily Inspection Procedures.....	229	
856. Proper Handling and Securement of OCUs.....	230	
857. Pullout Stopping Protection.....	231	
<b>AUTOMATED PROCESS CONTROL HUMP YARDS.....232</b>		
<b>Humping Operations</b>		
870. Humping.....	232	
<b>Pullback Operations</b>		
875. Equipment Beyond the Skate Retarders.....	233	
<b>DEFINITIONS.....234</b>		
<b>INDEX .....</b>		<b>246</b>



# GENERAL NOTICE

Safety is of the first importance in the discharge of duty.

Obedience to the rules is essential to safety.

Willingness to obey the rules is necessary in order to enter or remain in the service. Past practices not in conformity with the rules are unacceptable as an excuse for noncompliance.

The service demands the honest, intelligent, and courteous discharge of duty.

To obtain promotion, ability must be shown for greater responsibility.

Operating Rules have evolved from the experience of many people on many railroads over many years. This process will be continuing, and constructive suggestions to improve Operating Rules should be submitted to the employee's supervisor.

# GENERAL RULES

## A. Standard Time

Standard time may be obtained from the Control Station. Standard time zones are shown in the Timetable.

## B. Watch Requirement

When reporting for duty and while on duty, employees must have a reliable watch adjusted to the correct time. The watch must:

- (a) Be in good working condition.
- (b) Display hours, minutes, and seconds.  
Display hours in Arabic numbers (1, 2, 3, etc.)

## C. Rules, Bulletins, and Special Instructions

- (a) Employees whose duties are prescribed by these rules must maintain and have accessible while on duty a current copy of the following:
  - 1. The **Safety and General Conduct Rules**.
  - 2. The **Operating Rules and Timetable**, if their duties are affected by them.
  - 3. **Rules for Equipment Operation and Handling, NS-1**, if their duties are affected by them.
  - 4. **Hazardous Materials Rules, HM-1**, and the **Emergency Response Guide Book**, if they are involved in the shipment of hazardous materials.
- (b) Employees must be conversant with and obey the rules and special instructions. If in doubt as to their meaning, employees must apply to the proper authority for an explanation.
- (c) If bulletin instructions conflict with special instructions, the instructions bearing the later date will govern.
- (d) Employees performing service on another division must comply with the special instructions of that division.
- (e) Employees performing service on a foreign railroad, and foreign railroad employees performing service on Norfolk Southern, must comply with:

- The operating rules, timetables, and special instructions of the railroad they are operating on.
- The safety & general conduct rules, equipment operation and handling rules, and the hazardous material instructions of the railroad they are employed by.

#### **D. Notification**

Each Timetable, from the moment it takes effect, supersedes the preceding Timetable.

Notification of a new Timetable must be issued by Operations Bulletin at least 3 days before the effective date of the Timetable.

Stations, Controlled Points, and Interlockings are indicated in **Boldface** type.

#### **E. Operations Bulletins**

- (a) Operations Bulletins will be issued by the Division Superintendent and numbered consecutively on each division, beginning with No. 1 on or after January 1 each year, and will expire at 11:59 PM December 31 unless specified to expire sooner.
- (b) Contents of expiring bulletins may, if necessary, be consolidated and reissued as a new bulletin of the succeeding year.
- (c) Employees, before commencing a trip or tour of duty, must read all Operations Bulletins applicable to their assignment that were posted since they last worked.

#### **F. Documentation**

##### **(a) Train Clearance**

Engineers and Conductors must receive a current Train Clearance addressed to their train before leaving their initial station. Engineers and Conductors will be responsible for obtaining their respective Train Clearance from the mainframe. The Train Clearance must include all items and messages for the route over which they will operate including other Divisions and Foreign Lines. Engineers and Conductors must show the Train Clearance to other members of their crew. They must read and be familiar with the contents of the Train Clearance and assist the Engineer and Conductor in complying with the requirements contained therein.

Crewmembers must read the Train Clearance when received. They must be certain that the total number of items and messages indicated above the Train Dispatcher's initials correspond with actual numbers of items and messages listed in the Train Clearance. If any discrepancy is noted, the Train Dispatcher must immediately be contacted for further instructions.

When Engineer and/or Conductor are relieved before the completion of a trip, the Train Clearance held must be delivered to the relieving Engineer and Conductor. Engineer and Conductor must compare the Train Clearance before proceeding. When tying up on line-of-road, the Train Clearance must be retained. When this is done, Engineer or Conductor must contact the Train Dispatcher at the commencement of the next tour of duty to verify the Train Clearance and to receive further instructions, if any.

Each Train Dispatcher is responsible for the correctness of the contents of the Train Clearance issued to the train. Additions to and deletions of items in the Train Clearance must be made without delay and such changes must be promptly provided to concerned trains while en route.

Instructions contained in the Train Clearance must be complied with on all trips during the tour of duty.

### **(b) Waybills & Reports**

Conductors must see that proper waybills for cars to be moved are in their possession, and must examine waybills and comply with instructions shown. They must see that reports of cars set off, picked up, spotted, or pulled are properly prepared on prescribed forms and sent to the proper offices. Empty cars must be distributed as billed or as directed by proper authority.

### **G. Drugs and Alcohol**

An employee who reports for duty under the influence of alcohol or a prohibited drug (as defined by Company Policy on Alcohol and Drugs), or a derivative or combination of any of these, or who uses any of the foregoing while on duty, will be dismissed. Possession of any of the foregoing while on duty, or possession, use, or being under the influence of any of the foregoing while on Company property or in Company work equipment or vehicles, or occupying facilities provided by the Company, is prohibited.

*Revised 2/9/16*

## H. Terms for Crewmembers

(a) When applicable, the term:

- Conductor includes road Conductor, yard Conductor, and yard foreman.
- Trainman includes Conductor, road brakeman, yard brakeman, yard helper, switchman, utility employee, switch tender, and hostler helpers.
- Engineer includes hostlers.
- Train Dispatcher includes Control Operators.

(b) All words of gender apply equally to both genders.

## I. Reporting Non-Compliance

(a) Employees must assist in carrying out the rules and special instructions and must promptly report any non-compliance to the proper authority.

(b) Employees must immediately report to proper authority anytime another employee is observed or suspected of being under the influence or in possession of any prohibited substances in violation of **Rule G**. Such reports will be treated with confidentiality.

Employees who knowingly fail to report such occurrences are subject to discipline up to and including dismissal.

## J. Reporting Unusual Occurrences

Accidents, defects in track, bridges, signals or highway crossing warning devices, fires on or near the right of way, or any unusual condition that may affect the safe and efficient operation of the railroad must be reported promptly to the proper authority by the quickest means of communication.

# **CERTIFICATION AND QUALIFICATION**

## **K. Required Certification**

Employees certified in accordance with Federal Regulations must have a current certificate in their possession while on duty, and must display that certificate upon request to:

- (a) A representative of the Federal Railroad Administration.
- (b) A supervisor of Norfolk Southern.
- (c) A supervisor of another railroad when on that railroad.

Employees must:

- Use the corrective device(s) as indicated on the certificate while performing duties requiring certification.
- Have their certificate in their possession regardless of the service being performed.

Lost, damaged, or destroyed certificates must be promptly reported to the proper authority.

## **L. Required Examinations**

Employees must pass the required examinations.

- (a) Employees certified in accordance with Federal Regulations, who fail the required examination(s) will not be qualified to perform certified service until the employee achieves a passing score during a re-examination.
- (b) All other employees who fail the required examination(s) must be re-examined within 30 days. Employees who fail the second examination, or who fail to be re-examined within 30 days, will not be qualified to perform service.

## **M. Qualifications**

- (a) FRA has established minimum qualifications for Conductors, Locomotive Engineers, and Remote Control Operators (RCOs). The rule requires railroads to have a formal evaluation process to determine competency before permitting employees to serve as a Conductor, operate a locomotive, train, or Remote Control Transmitter.

The Federal Regulation requires railroads:

1. Make a series of four (4) determinations about a person's competency, which are:
    - (a) Eligibility.
    - (b) Vision and hearing accuracy.
    - (c) Demonstration of knowledge.
    - (d) Demonstration of performance skills.
  2. Devise and adhere to an FRA approved training program.
  3. Employ standard methods for identifying and monitoring the performance of Conductors, Engineers, and RCO's.
- (b) Conductors, Engineers, and RCO's must remain qualified on those districts, terminals, or divisions their seniority allows them to work.**
1. Conductors must contact the Trainmaster or Chief Dispatcher prior to accepting an assignment called to operate over a main track or other than main track which they have not operated over in one (1) year. If necessary, the Trainmaster or Chief Dispatcher will arrange for a physical characteristics review or a qualifying trip, as appropriate.

If the Conductor has not been over the main track in three (3) years or more, the Trainmaster or Chief Dispatcher will arrange for a qualifying trip prior to the Conductor accepting the assignment.
  2. Engineers or RCO's must contact the Division or District Road Foreman prior to accepting an assignment called to operate over a main track which they have not operated over in 6 months. The Division or District Road Foreman will arrange for either a physical characteristics review or a qualifying trip prior to the Engineer / RCO accepting the assignment.

If the Engineer or RCO has not been over the main track in one (1) year or more, the Division of District Road Foreman will arrange for a qualifying trip prior to the Engineer/RCO accepting the assignment.

Employees called to perform service as Conductor, Engineer, or RCO over any portion of the railroad for which they are not qualified must immediately inform their supervisor.

## **N. Conductors, Locomotive Engineers, and Employees Seeking Initial Certification**

Each certified Conductor, Train Service Engineer, Remote Control Operator, or Locomotive Servicing Engineer, and any trainee seeking initial certification is required to report motor vehicle incidents to the employing railroad within 48 hours of being convicted for, or completed state action to cancel, revoke, suspend (including training assessed in lieu of suspension) or deny any motor vehicle driver's license for:

- (a) Operating a motor vehicle while under the influence of or impaired by alcohol or a controlled substance.
- (b) Refusal to undergo such testing as is required by state law when a law enforcement official seeks to determine whether a person is operating a vehicle while under the influence of alcohol or a controlled substance.

The report must be made to the Division Road Foreman, or in his/her absence, the Division Superintendent or Assistant Division Superintendent.

## **O. Acting as Pilot**

While acting as a Pilot, Engine Service Employees will:

- occupy the operating compartment of the leading locomotive
- provide instruction on safe movement to the operator

In the absence of a qualified Conductor a pilot must perform the duties of Conductor and conform to the rules relating to that position.

A pilot may enlist the assistance of crewmembers in any duties relative to the prompt and safe movement of their trains.

## **P. Dispatcher Qualification**

- (a) Train Dispatchers must be qualified on a dispatching district before accepting an assignment.
- (b) A Train Dispatcher who has not performed service on a dispatching district during the previous 12 months must not accept assignment to that position without approval of the designated supervisor.

(c) Train Dispatcher trainees are prohibited from performing any dispatching duties except under the direct observation of a supervisor or qualified Train Dispatcher.

*Revised 02/02/2015*



## **Q. RWIC and Equipment Operator Qualification**

- (a)** Operators of On-Track equipment or employee in charge of maintenance operations that affect the safe movement of trains must be examined and qualified on these rules or be working under immediate (on-the-job) supervision of personnel who have been examined and qualified on these rules.
- (b)** Only a roadway worker who is qualified will establish or have control over working limits for the purpose of establishing On-Track safety.

## **R. Tampering and Unauthorized Devices**

- (a)** Unless properly authorized, employees are prohibited from restricting or interfering with the normal intended function of any device or equipment on locomotives, cars, or other railroad property except in case of emergency, in which case report must be made to the proper authority.
- (b)** The use of unauthorized devices is prohibited.
- (c)** Federal Railroad Administration regulations prohibit tampering with safety devices on trains. The rules establish standards of conduct for railroads and individuals who operate or permit to be operated locomotives with willfully disabled safety devices.
- (d)** Safety device means equipment that is used either to assure that the locomotive Operator is alert, not physically incapacitated, aware of and complying with the indications of a signal system or other operational control system or to record data concerning the operation of that locomotive or the train it is powering. Any individual who willfully disables such a device is subject to civil penalty and to disqualification from performing safety-sensitive functions on a railroad.
- (e)** An individual who operates or permits a train to be operated when he knows that the controlling locomotive of that train is equipped with a safety device that has been willfully disabled is subject to a civil penalty and disqualification.
- (f)** Disabled is defined to mean “to unlawfully render a device incapable of proper and effective action or to materially impair the functioning of that device.”

## **S. Riding Locomotives and Freight Trains**

- (a)** No more than 2 persons, other than duly assigned train and engine service employees, designated trainees, and required steam locomotive personnel in connection with the operation of steam locomotives, may ride on the controlling locomotive.
- (b)** Those 2 persons, not duly assigned, may be as follows:
  - 1. Government representatives with proper identification and credentials,
  - 2. Transportation, Mechanical and Engineering Department personnel,
  - 3. AMTRAK and commuter passenger service supervisory personnel (in connection with train operations by those agencies), in the performance of their duties, or
  - 4. A designated rider on Steam Locomotives as approved by the Sr. General Foreman Steam or DRFE/RFE riding the locomotive.
- (c)** Persons, other than those listed in (a) and (b), must have written authority from the Executive Vice President Operations, and must be accompanied by a division qualified transportation supervisor.

# ATTENTION TO DUTY

## 1. Job Safety Briefings

(a) A Job Safety Briefing is communication between a group or by an individual (if on an independent assignment) to review:

- Work to be performed
- Potential exposures
- Necessary safeguards for the task to be performed
- Applicable rules and procedures
- Tools, equipment, and materials needed
- Weather conditions
- Job location or work area
- Work assignments — group or individual

(b) Participation and involvement in Job Safety Briefings are required and must be done:

- At the beginning of each job
- When the work changes
- When the work becomes confusing or new tasks are started
- When a rule violation is observed

(c) In signaled territory, all crewmembers must hold the following Job Safety Briefing anytime a signal is received requiring the train to approach the next signal prepared to Stop:

- Distance to next signal
- Location of next signal and sight distance
- Physical constraints (e.g.: curvature, sight distance, grade, tonnage, weather)
- Status of air and dynamic brakes and planned stopping technique

During the Job Safety Briefing, the Engineer must confirm to the crew:

- The plan for stopping short of the next signal, and
- A fixed stopping point, not less than 500 feet short of the next signal, to be designated by a landmark or a distance if a

landmark is not available. The train may be operated closer than 500 feet from the next signal, if necessary for the train's rear to clear a clearance point, road crossing(s), or other physical point

Following the Job Safety Briefing:

- Employees located in the cab of the controlling locomotive must cease any communication unrelated to compliance with the Approach signal or operation of the train.
- All crewmembers must remain alert and in communication with the Engineer. If the Engineer does not prepare to stop the train short of the agreed upon stopping location, employees must take immediate action to stop the train, to include an emergency brake application, if necessary.
- One (1) mile from the planned stopping location, the Conductor must confirm the planned stopping location with the Engineer.

**(d)** When operating On-Track equipment on the rail, participation and involvement in Job Safety Briefings is required by all occupants:

- Prior to entering a Controlled Point, to confirm if the Controlled Point is included in the Track Authority limits.
- One mile in advance of the milepost limit of the Track Authority, when mileposts are used as a designated limit of the Track Authority, to confirm the current milepost and the plan to stop at the designated milepost limit of the Track Authority.

Following the Job Safety Briefing all occupants of the On-Track equipment must:

- Cease any communication unrelated to railroad operations
- Remain alert and in communication with the Operator to ensure action is being taken to stop the movement short of the Control Point or milepost limit of the Track Authority, if necessary.

If a single occupant is operating On-Track equipment in the lead of other On-Track equipment, these Job Safety Briefing requirements must be announced over the radio by the single occupant in the lead and confirmed by an occupant of the following On-Track equipment.

- (e) The person conducting the Job Safety Briefing must confirm that everyone involved understands all the instructions.

*Revised 7/14/17*

## **2. Prohibited Activities**

While on duty:

- (a) Undivided attention to duty is required. Employees must not engage in any activity that will:
- Jeopardize their personal safety or the safety of others
  - Interfere with or distract their attention from their work
  - Circumvent the requirements of the rules or special instructions
- (b) Sleeping is prohibited. An employee lying down or in a slouched position with eyes closed or with eyes covered or concealed will be considered sleeping.
- (c) Use of a cell phone, PDA, or similar device while driving a motor vehicle is prohibited unless being used for voice communication in “hands-free” mode.
- (d) CDL drivers are prohibited from using a cell phone, PDA, or similar device while driving a motor vehicle that requires a Commercial Driver’s License (CDL).

**EXCEPTION:** CDL drivers operating without passengers may receive a phone call using “hands-free” mode.

## **3. Napping**

Train and Engine Service employees, except yard service employees, are permitted to “nap” when their train is being delayed, or when waiting for the arrival or departure of their train under the following conditions:

### **(a) Napping Period**

#### **1. On a Locomotive**

- The train is stopped and no duties are required, and
- No crewmember is on the ground, or on rail equipment, and

- No other employee is assisting with preparation or repairs to the train

The napping period must not exceed 45 minutes and one crewmember must remain awake and on the locomotive at all times. This employee must not be a trainee or a utility employee.

2. **Not On a Locomotive** – in terminals or at outlying reporting locations, napping is allowed when the train is delayed and no duties are required. One crewmember must remain awake at all times.

**(b) Train Delay** – no train or work may be delayed due to napping. Before napping, employees must ensure all duties have been performed (e.g. reviewed bulletins, printed train clearance, obtained OSS paperwork, etc.).

**(c) Train Securement** – before napping by any crewmember on a locomotive is allowed, the Locomotive Engineer must make a minimum 10 PSI brake pipe reduction, open the generator field switch, and center the reverser.

**(d) Job Briefing** – a job briefing must be conducted and all crew members must agree that napping will not interfere with any duties. Crew members must agree on the designated employee responsible for staying awake during the napping period.

The employee designated to remain awake must ascertain the length of delay and remain current on this information. The designated employee must also wake the napping employees 10 minutes before the train delay ends, or at the end of the napping period. After waking, a job briefing between all crew members must be conducted. This job briefing must include a review of the train clearance, movement authorities, and any necessary duties to be performed.

#### 4. **Performing Duties Safely**

**(a)** All employees must follow instructions from proper authority, and must perform all duties efficiently and safely.

**(b)** In case of doubt or uncertainty, the safe course must be taken.

## **5. Electronic Devices**

### **(a) General Use**

The use of any electronic device is prohibited if that use will interfere with any employee's performance of duties.

No individual located in the cab of a controlling locomotive may use an electronic device unless a safety briefing is held with all crewmembers and it is determined such usage will not interfere with any employee's performance of duties.

### **(b) Personal Electronic Devices**

1. Employees must have all personal electronic devices, including earpieces, turned off and stored out of sight and not on the employee's person:
  - When on a moving train or engine.
  - When in the foul of the track, or within 4 feet of the nearest rail.
  - When operating On-track equipment on the rail.
  - Within the Division Dispatch Centers, Operator's and Yard-master's offices.
2. Train and Engine Service employees must have all personal electronic devices, including earpieces, turned off and stored out of sight and not on the employee's person:
  - When any member of the crew is on the ground, or on rail equipment.
  - When any other employee is assisting with preparation or repairs to their train.

Additionally, Train and Engine Service employees are prohibited from using personal electronic devices for any function other than voice or text communication when on a train or engine.

### **(c) Railroad-Supplied Electronic Devices**

1. Employees must have each railroad-supplied cell phone turned off, and earpieces removed:
  - When in the foul of the track, or within 4 feet of the nearest rail.

- When operating On-Track equipment on the rail.
2. Train and Engine Service employees may only use railroad supplied electronic devices for the following authorized business purpose:
    - To send or receive work related information with customers or other railroad employees as necessary in the performance of duties.
  3. Engineers and Remote Control Operators operating a locomotive, and Train and Engine Service employees in deadhead status located in the cab of the controlling locomotive must have all railroad-supplied electronic devices turned off with earpieces removed:
    - When on a moving train or engine.
    - When any crewmember is on the ground, or on rail equipment.
    - When any other employee is assisting with preparations or repairs to their train.
  4. Crewmembers located outside the cab of a controlling locomotive may use a railroad-supplied electronic device provided the employee is not fouling a track, or within 4 feet of the nearest rail, and all crewmembers agree it is safe to use the device.

**(d) Exceptions**

1. Employees may use the following if such use does not interfere with any employees performance of safety related duties:
  - a. Any electronic device:
    - To respond to an emergency situation involving the operation of the railroad or encountered while performing a duty for the railroad.
    - To refer to a rule, timetable, or special instruction. When employees, excluding passengers, are located on a train, engine, or on-track equipment, the movement must be stopped when using an electronic device for this purpose.



- For railroad communication with the Train Dispatcher and Railroad Supervisors when the railroad radio fails or malfunctions.
  - b. A medical device consistent with the railroad's standards for fitness for duty.
  - c. A digital watch whose only purpose is as a timepiece.
2. The above restrictions do not apply to the use of railroad radios, electronic control system displays in the locomotive cab, or remote-controlled transmitters used to operate a train, conduct switching operations, or control switches.
  3. Mechanical Department employees working within the confines of a shop facility will be governed by departmental instructions.

*Revised 1/17/17*

## **6. Clean Cab Communications**

Individuals located in the cab of the controlling locomotive, and all occupants of On-Track equipment, must cease all communication unrelated to the safe movement of the train or On-Track equipment:

- When receiving, copying or repeating a mandatory directive.
- When clearing or OS'ing a Track Authority.
- When making a positive determination that a train for which the movement is restricted has passed.
- For roadway workers, when granting joint occupancy or when confirming that all employees granted a joint occupancy are in the clear.

*Revised 7/27/15*

# SAFETY CRITICAL RULES

## 20. Prohibited Acts

### (a) Riding Equipment

Employees are prohibited from riding:

1. Between moving cars, or on the leading end of a car, with body positioned between the gauge of the track, except when necessary to operate the handbrake to control the movement. **NOTE:** This does not prohibit an employee from riding under the slope sheet of a hopper or covered hopper.
2. In the sill step of a moving car unless equipped with a horizontal grab iron at least waist high, or two vertical grab irons, so located that the employee can stand upright on the step.
3. The side of equipment on tracks restricted by Special Instructions account close track centers.
4. On close clearance side, between, or on leading end of equipment moving adjacent to platform, building, or close-clearance structure. They must not stand between moving equipment and adjacent platform, building, or close-clearance structure.
5. The side of equipment on intermodal yard tracks used for loading, and unloading or parking trailers, containers, or chassis. These areas of the track are commonly called “pad tracks” or “strips.”

When riding loaded TOFC or COFC equipment, employees must not place any portion of their body in pinch points between:

- Raised bridge plates and equipment loaded on TOFC cars.
- Containers and chassis of highway vehicles loaded on TOFC cars.
- Containers and the container mounting device on COFC cars.

**NOTE:** A “pinch point” is any point at which it is possible to be caught between the moving parts of equipment, between

moving and stationary parts of equipment, or between the material being worked and the moving parts of equipment.

6. The side of equipment on automotive ramp and prep yard tracks, or tracks immediately adjacent to automotive ramp and prep yard tracks, unless specifically authorized by division or terminal instructions.
7. In or placing arms or legs in cars with lading that may shift, except when necessary to load or unload material in cars moving no faster than 5 MPH.
8. The end of a car if a shift of lading on adjacent car can cause injury.
9. On tank cars, unless positioned in the sill step of a tank car equipped with two vertical grab irons. *Added 4/3/17*

#### **(b) Mounting / Dismounting or Crossing Over Between Equipment**

Employees are prohibited from:

1. Crossing over between moving coupled cars, or on end of moving cars.
2. Crossing over between coupled cars unless duties require, then must maintain secure handhold and use a sill (end) platform if possible.

#### **(c) Working On or About the Tracks**

Employees are prohibited from:

1. Walking or standing between the rails or in the foul (e.g. head of ties) of a track unless necessary in performance of their duties.
2. Leaving equipment in the foul of any adjacent track.
3. Adjusting couplers or coupling air hoses between equipment on a bowl (classification) track in an automated hump yard until confirmation is received that the switch providing access from the hump has been lined against movement to that track and the control lever for that switch has been blocked.
4. Sitting, standing, or stepping on handrails, brake wheels, cut levers, couplers, sliding center sills or trucks.

**NOTE:** Employees loading, unloading, or repairing cars may, if necessary, stand on couplers or trucks when equipment is protected by blue signal. Stepping on a coupler and / or cut lever while crossing standing cars protected by blue signal is prohibited.

5. Adjusting couplers or knuckles with foot.
6. Operating hand brakes with foot.
7. Stepping on rails, guard rails, switches, or frogs.
8. Leaning out of windows or from walkways of locomotive when approaching or passing bridge structures that extend above track.

## 21. Fouling a Track

Fouling a Track means the placement of an individual or equipment in such proximity to a track that the individual or equipment could be struck by a train, locomotive, or other railroad equipment.

- (a) Employees must expect the movement of trains, engines, or cars at any time, on any track, in either direction.
- (b) Fouling a track may be necessary in the performance of railroad work.
- (c) Proper safeguards must be in place before a track is fouled and may include protection by one of the following:
  1. Blue Signals.
  2. Roadway Worker Protection Rules.
  3. Track and Time limits.
  4. Application of Safety and Operating Rules concerning crossing, walking adjacent to, mounting and dismounting, and going around and between equipment.
  5. Communication and understanding with the employee controlling the movement.
  6. Employees must maintain a vigilant lookout for and detect the approach of a train, locomotive or other railroad equipment moving in either direction.

- (d) **The 90-Degree Principle** — cross tracks at a right angle to maximize the field of vision within the fouling space. Employees must look both ways and apply the 90-Degree Principle when conditions permit.

## 22. Fouling Equipment

- (a) Employees must not stand on track in front of closely approaching equipment, or step between coupled moving cars or locomotives, for any reason. They must not step between or immediately in front of standing cars or locomotives unless necessary in the performance of duty, and then only after arranging for protection against the equipment being coupled to or moved.

Never make adjustments to moving equipment.

### (b) Going Between Equipment

1. Employees must not go between standing separated cars or locomotives for any reason unless the equipment is separated by at least 50 feet.

**EXCEPTION:** Special Instructions will govern when an approved coupler alignment device is being used.

2. When adjusting coupler or knuckle, employees must stand to one side with feet clear of falling knuckle.

### (c) Crossing or Fouling Tracks

1. Employees must not cross or foul tracks between standing separated cars or locomotives unless the equipment is separated by at least 50 feet and the employee maintains at least 10 feet of separation between themselves and the nearest equipment.
2. Employees must not cross or foul tracks around the end of standing cars or locomotives unless the employee maintains at least 10 feet of separation between themselves and the equipment.
3. Employees must expect sudden movement by cushion under frame draft gear when crossing or fouling tracks around or between standing equipment.

### (d) Establishing 3-Step Protection

If a locomotive is coupled to standing equipment or is on the same track in a position to couple to the equipment, an employee must communicate with the Engineer and establish “3-Step Protection” before fouling the equipment for the purpose of inspecting, making adjustments, repairing or operating appliances.

The employee must take the following precautions before fouling the equipment:

1. Verbally request “3-Step Protection” from the Engineer. To communicate that protection is required or that protection has been provided, positive identification must be established between the Engineer and each individual who requests protection. When using the radio to request or grant “3-Step Protection”, employees must designate their occupation, job symbol, and engine number. “3-Step Protection” is not required if blue signal protection is established.
2. When protection is requested, the Engineer must take three actions called “3-Step Protection”.
  - a. Fully apply the independent brake; and when air is coupled and cut in, make a brake pipe reduction to sufficiently hold the equipment.  
**NOTE:** When necessary to foul equipment to determine air pressure for the performance of air brake inspections and to perform emergency air brake repairs that require the train brakes to be released, a brake pipe reduction will not be required. Employees must allow slack to adjust before fouling equipment.
  - b. Place the reverser lever in neutral position.
  - c. Open the generator field switch.
3. The Engineer must acknowledge to each requesting employee that “3-Step Protection” is established. The Engineer must maintain “3-Step Protection” until notified by each requesting employee that the protection is no longer required. If the Engineer who is providing “3-Step Protection” must leave the operating compartment of the locomotive unattended prior to the employees relinquishing their protection, the Engineer must contact each employee and require that they position themselves in the clear of the equipment.

#### **4. Remote Control Operations**

The operator in control of the locomotive must set the speed to stop, place the directional control in neutral, and apply the locomotive and automatic brakes. These settings must be maintained until notified by the employee(s) requesting “3-Step Protection” that the protection is no longer required.

#### **(e) Brandt Truck and Locomotive Crane Operations**

Prior to fouling equipment being operated with, or coupled to, a Brandt Truck or Locomotive Crane, the employee must obtain “3-Step Protection” from the Operator in control. When protection is requested, the operator must set the gear selector to neutral, fully apply the parking brake, and make an automatic brake pipe reduction sufficient to hold the equipment. These settings must be maintained until notified by the employee(s) requesting “3-Step Protection” that the protection is no longer required.

### **23. Single Engineer Procedures for Fouling Equipment**

A Single Engineer working alone as a one-person crew (hereinafter referred to as a ‘Single Engineer’) without blue signal protection must not go between standing equipment to couple or uncouple a pusher consist from a train, couple or uncouple locomotives to be set out or picked up, or engage in any other work that places the Single Engineer on the ground between standing equipment or at the end of equipment where the employee would be subject to injury if unexpected movement of the equipment should occur, unless the requirements listed below are met:

- (a)** The work being performed must be limited to one or more of the following functions:
  1. Couple or uncouple air hoses and other electrical or mechanical connections.
  2. Prepare rail cars for coupling.
  3. Set wheel blocks or wheel chains.
  4. Conduct air brake tests to include cutting air brake components in or out.
  5. Inspect, test, install, remove or replace a rear-end marker device or end-of-train device.

(b) Locomotives in the Single Engineer's charge must either be coupled to the train or other railroad rolling equipment to be assisted, or stopped at least 50' from the train or equipment, and secured as prescribed by **NS-1 Rule L-236(a)** except the employee will apply the hand brake only on the controlling unit instead of each unit. An approved orange tag (with the words "ASSIGNED LOCOMOTIVE — DO NOT OPERATE") must be displayed on the control stand of the controlling unit.

(c) Before assisting another train, a Single Engineer must communicate directly with the crew of the train to be assisted. The crew of both movements must notify each other in advance of all moves to be made by their respective equipment. Prior to attachment or detachment of the assisting locomotive(s), the crew of the train to be assisted must inform the Single Engineer that the train is secured against movement. The crew of the train to be assisted must not move the train or permit the train to move until authorized by the Single Engineer. Communication between the Single Engineer and the crew of the movement being assisted will be through direct verbal contact or by radio.

**NOTE:** The term "train" as used above will include yard movements when assisted by a Single Engineer.

(d) Before picking up or setting off locomotives, a Single Engineer must first secure permission from the Train Dispatcher, Yardmaster, or other employee responsible for directing train and engine movements in the area. The employee will not grant such permission until effective measures have been taken to ensure that other movements will not enter the affected track section while the work is being performed. The consist must be secured as prescribed by **NS-1 Rule L-236(a)**, except the employee will apply the hand brake only on the controlling unit instead of each unit, and an approved orange tag (with the words "ASSIGNED LOCOMOTIVE — DO NOT OPERATE" must be displayed on the control stand of the controlling unit). The Single Engineer will promptly notify the employee who granted the permission as soon as the work is completed.

## 24. Protection in Bowl (Classification) Tracks

Before train or engine service employees adjust couplers or couple air hoses between equipment on a bowl (classification) track in an automated hump yard, they must know that the switch providing



access from the hump has been lined against movement to that track and the control lever for that switch has been blocked. This protection must not be removed until authorized by the person who asked for it.

## **25. Occupying Roofs of Freight Cars**

Train and engine service employees must not occupy the roof of a freight car or caboose under any circumstances. Other employees whose duties require them to occupy roof of a freight car or caboose may do so only when equipment is standing.

**NOTE:** Mechanical Department employees may occupy the roof of a freight car or caboose if approved fall protection is used.

## **26. Riding Side of Equipment**

- (a) Employees riding on the side of moving equipment must maintain lookout in the direction of movement and must frequently look back.
- (b) Employees must not ride a car over 60 feet long through a turnout or crossover, on the side next to equipment on an adjacent track.

## **27. Close Clearance**

Some platforms, bridges, and other structures, switch stands, tunnels, and equipment on adjacent track will not clear a person on the top or side of a car or engine. Employees must become familiar with these and other close clearance locations and protect themselves from injury.

# COMMUNICATION

## GENERAL REQUIREMENTS

### 30. Communication Equipment Requirements – Trains

The occupied controlling locomotive must be equipped with a working radio upon departure from a terminal.

Each train must also have another form of working wireless communication upon departure from a terminal. This other form of communication may be provided by a radio on another locomotive in the consist, a portable railroad radio, or a device such as a cellular telephone.

### 31. Communication Equipment Requirements – Maintenance of Way Equipment

Multiple units of equipment operating without locomotive assistance and traveling together between work locations under the same movement authority must have a working radio on at least one of the units. Operators of machines not equipped with a working radio must have communication capability such as hand signals, light signals, or horn signals. A single unit traveling between work locations must have a working radio.

### 32. Communication Equipment Requirements – Maintenance of Way Work Gangs

Each work gang will have a minimum of 2 working radios at a work site to provide intra-gang communications.

### 33. Communication Equipment Requirements – Roadway Worker in Charge

The worker in charge of a roadway work group must maintain immediate access to a working radio.

### 34. Communication Equipment Requirements – Lone Worker

Each roadway worker when functioning as a lone worker must maintain immediate access to a working radio.

### **35. Communication Equipment Requirements – Exceptions**

Working radios are not required for a roadway worker in charge, a lone worker, Maintenance of Way Equipment, or Maintenance of Way Work Gangs when the work location:

- (a) Is physically inaccessible to trains.
- (b) Has no through or adjacent rail traffic during the period when roadway workers will be present.

### **36. General Instructions for the Use of Radios**

Employees whose duties are prescribed by the Operating Rules will use radio communication in connection with railroad operations when radio equipment is available.

### **37. Radio Use**

Railroad radio will be used:

- (a) Only in connection with Company business.
- (b) In compliance with the Operating Rules.
- (c) So as not to circumvent the requirements regarding any rules or instructions

### **38. Radio Channels**

Each radio used in a railroad operation must be tuned to the appropriate channel designated by Timetable or special instruction and adjusted to receive communications.

### **39. Radio Transmission Restrictions**

Employees will not transmit:

- (a) Any false distress communication.
- (b) Any unnecessary, irrelevant or unidentified communication.
- (c) Any obscene, indecent, or profane language.

### **40. Equipment Responsibilities**

Employees are responsible for the proper care and use of radio equipment.

## **41. Taxi and Relief Crews – Communication**

When crews are called for Relief Crew service or to deadhead (taxi) from one location to another, Conductors must leave their railroad radios on and tuned to the appropriate channel unless the taxi providing service is equipped with an operable radio to receive and transmit on the railroad channel. This will allow the Train Dispatcher or other designated employee to contact the crew, if necessary. This will not be required of a crew that has been relieved due to the Hours of Service Law.

## **42. Federal Communications Commission (FCC) Requirements**

- (a)** Adjustments to railroad radio sets will be made only by specifically authorized personnel. These personnel must carry the proper FCC license or verification card when on duty.
- (b)** Citizen band radios may not be used for railroad operating purposes.

# **RADIO FAILURE, TESTING AND EMERGENCIES**

## **45. Radio Voice Test**

Employees will test each radio and any supplementary wireless communication device used in connection with a railroad operation as soon as practicable to ensure that the radio functions as intended before the commencement of that railroad operation. The test will consist of an exchange of voice transmissions with another radio. The employee receiving the transmission must advise the employee conducting the test of the clarity of the transmission.

## **46. Malfunctioning Radios**

Employees will remove from service and tag any radio or supplementary wireless communication device found not to be functioning properly. The radio will not be returned to service until it has been repaired.

## **47. Radio Removed From Service**

When a radio is removed from service, each crewmember of the train and the Train Dispatcher or other supervisor designated by special instruction will be notified.

## **48. Locomotive Radio Failure**

If a locomotive radio on the controlling locomotive fails en route, the train may continue until the earlier of:

- (a) The next calendar day inspection of the locomotive.
- (b) The nearest forward point where the radio can be repaired or replaced.

## **49. Reporting Emergencies by Radio**

An initial emergency transmission will be preceded by the word “emergency” repeated 3 times. An emergency transmission will have priority over all other transmissions and the frequency or channel will be kept clear of non-emergency traffic for the duration of the emergency communication.

## **50. Radio – Field Emergency Situations**

When an emergency situation arises, an employee will transmit **9-1-1** from the keypad of a locomotive radio (or other dial-pad-equipped radio) which will transmit an “EMERGENCY” call to the Train Dispatcher. This emergency indication will be immediately displayed on all Train Dispatcher screens which display the activated base station(s). When the Train Dispatcher receives the **9-1-1** call on the monitor, console audio is also triggered allowing immediate access to the Train Dispatcher who must immediately respond.

# **RADIO COMMUNICATION**

## **51. Initiating a Radio Transmission**

Before transmitting by radio, employees will listen to ensure that the channel to be used is not already in use.

## **52. Identifying a Radio Transmission**

To initiate a radio transmission, employees will identify each wayside, base, or yard transmitting station by:

- (a) The name or initial letters of the railroad.
- (b) The name and location of the office or other unique designation.

## **53. Identifying a Mobile Station**

Employees will identify each mobile radio station by:

- (a) The name or initial letters of the railroad.
- (b) The train name or number, if one has been assigned or other appropriate unit designation.

**NOTE:** When necessary, use the word “locomotive” or “engine,” “inspection car,” “automobile,” or other unique identifier that indicates to the listener the precise mobile transmitting station.

### **Examples of Correct Procedure to Initiate or Acknowledge Radio Communication**

- “NS Track Supervisor Brown Automobile 1881 at Argos calling Fort Wayne Dispatcher, over.”
- “This is NS Dispatcher Fort Wayne, over.”
- “NS Yardmaster at Ranger Tower Bellevue calling Yard Engine 2340, over.”
- “This is NS Conductor on Yard Engine 2340, over.”
- “Brakeman Jones, Norfolk Southern Train 58, calling the Engineer, over.”

## **54. Achieving Positive Radio Identification**

If positive identification is achieved in connection with switching, classification, and similar operations wholly within a yard, fixed and mobile units may shorten their identification after the initial transmission and acknowledgment.

## **55. Continuous Positive Radio Identification**

If an exchange of communication continues without substantial interruption, positive identification must be repeated each 15 minutes.

## **56. Verification of Radio Contact**

Verify that radio contact has been made with the person or station with which communication is intended by listening for an acknowledgment. If the station acknowledging a transmission fails to identify itself properly, the employee will require a proper identification before proceeding with the transmission.

## **57. Acknowledging Receipt of a Transmission**

Employees will promptly acknowledge the receipt of a radio call, identifying the receiving station according to prescribed rules.

**NOTE:** An employee need not attend the radio if this would interfere with other immediate duties relating to the safety of railroad operations.

## **58. Repeating Transmissions**

An employee who receives a transmission will repeat it to the transmitting party unless the communication:

- (a) Relates to yard switching operations.
- (b) Is a recorded message from an automatic alarm device.
- (c) Is general in nature and does not contain any information, instruction or advice that could affect the safety of a railroad operation.

## **59. Ending a Transmission – Response Expected**

At the close of each transmission, except for transmissions relating to yard switching operations, to which a response is expected, the transmitting employee will say “over.”

## **60. Ending a Transmission – Response Not Expected**

At the close of each transmission, except for transmissions relating to yard switching operations, to which no response is expected, the transmitting employee will state the employee’s identification followed by the word “out.”



# SIGNALING EQUIPMENT

## 65. Equipment

The following signals will be used by employees:

- (a) Day Signals: A red flag and fuses.
- (b) Night Signals: A white light and fuses.

Signaling equipment must be kept in the operating compartment of locomotives and in cabooses available for immediate use.

## 66. Care and Use

- (a) Employees whose duties may require them to give signals must provide themselves with the proper appliances, keep them in good order and ready for immediate use.
- (b) Signals must be used in accordance with the rules. Employees must maintain a constant lookout for signals affecting their movement.

## 67. Fuses

- (a) A train or engine finding a burning fusee unattended on or near its track must immediately reduce to Restricted Speed and proceed at that speed for 1 mile.
- (b) An unattended burning fusee beyond the nearest rail of an adjacent track will not apply to the track on which train or engine is moving.

## **HAND SIGNALS**

### **68. Hand Signals**

Hand signals include signals given with a flag, white light, or fusee.

<b>Manner of Using</b>	<b>Indication</b>
<b>(a)</b> Swung horizontally at right angle to the track.	Stop
<b>(b)</b> Slight horizontal movement at arm's length.	Reduce speed
<b>(c)</b> Raised and lowered vertically.	Proceed
<b>(d)</b> Swung vertically in a circle at right angle to the track.	Back
<b>(e)</b> Swung horizontally above the head.	Apply air brakes
<b>(f)</b> Held at arm's length above the head.	Release air brakes
<b>(g)</b> Any object waived violently by anyone on or near the track.	Stop

### **69. Giving and Receiving Hand Signals**

Hand signals must be given from a place where they may be plainly seen and in such a way that they cannot be misunderstood.

Movement must be stopped if:

- (a)** There is doubt concerning the meaning of a signal.
- (b)** There is doubt for whom the signal is intended.
- (c)** There is an unexpected disappearance from view of:
  1. The employee giving signals.
  2. The light by which signals are given.

## **LOCOMOTIVE HORNS**

### **70. Locomotive Horn Signals**

The Engineer is responsible for properly sounding locomotive horn signals required by rule or law.

Unnecessary use of the horn is prohibited.

When employees are working on or near the track, Engineers must sound signal **70(j)** when approaching or passing.

**NOTE:** The signals prescribed are illustrated by “O” for a short sound “—” for longer sounds. The sound of the horn should be distinct, with intensity and duration proportionate to the distance signal is to be conveyed.

<b>Sound</b>	<b>Indication</b>
<b>(a)</b> O	When running, acknowledges a hand signal to stop. When standing, acknowledges a signal to apply brakes.
<b>(b)</b> — —	Release brakes. Proceed.
<b>(c)</b> O O	Answer to any signal not otherwise provided for.
<b>(d)</b> O O O	Back. Answer to <b>Rule 68(d)</b> .
<b>(e)</b> O O O O	Call for signals.
<b>(f)</b> — — O —	<p><b>1.</b> When a train or engine is approaching a tunnel(s).</p> <p><b>2.</b> In addition to the below whistle signal requirements for public crossings, the whistle must also be sounded in the same manner by trains approaching any highway rail grade crossing or structure where whistle posts are displayed. The signal must be prolonged or repeated until the engine occupies the crossing.</p> <p><b>A.</b> When approaching public highway-rail grade crossings with the engine in front, start whistle signal at least 15 seconds but not more than 20 seconds before occupying the crossing.</p> <p><b>B.</b> Trains and engines exceeding 45 MPH must begin the signal at or about the whistle post but not more than one-fourth (1/4) mile from the public grade crossing.</p> <p><b>C.</b> When a train or engine is approaching a public grade crossing and is delayed, the movement will not occupy the crossing until whistle signal is complied with.</p> <p><b>EXCEPTION:</b> When a train or engine is stopped at a location where the lead engine could occupy a public highway-rail grade crossing in less than 15 seconds, the whistle signal may be sounded for less than 15 seconds provided:</p>

Sound	Indication
	<ol style="list-style-type: none"> <li>1) The public highway grade crossing is not obstructed.</li> <li>2) The public highway grade crossing is equipped with:               <ol style="list-style-type: none"> <li>a. Automatic warning lights that have been activated for at least 20 seconds.</li> <li>b. Gates have been fully lowered for at least five (5) seconds.</li> </ol> </li> <li>3) No conflicting highway movements are approaching the public highway-rail grade crossing.</li> </ol>
<b>(g)</b> ———	Approaching passenger stations and drawbridges.
<b>(h)</b> – – O	Approaching passing standing trains.
<b>(i)</b> O –	Inspect train line for leaks or for brakes sticking.
<b>(j)</b> Succession of short blasts	Alarm for employees, roadway workers, other persons, or animals on or near the track.
<b>(k)</b> – O	When running against the current of traffic: <ol style="list-style-type: none"> <li>1. Approaching stations, curves, or other points where view may be obstructed and as an advance warning to employees.</li> <li>2. Approaching and passing trains.</li> </ol>

## 71. Locomotive Horn Failure

Anytime the horn on the lead locomotive fails en route, the Train Dispatcher and LCDI desk in Atlanta must be immediately notified.

The movement may proceed at authorized speed, stopping before fouling any road crossing where sounding the whistle is required by rule or special instruction. A crewmember must be on the ground at the crossing to warn traffic until the leading end of the movement has occupied the crossing.

These actions are not required if:

1. Crossing gates, if equipped, are in the fully lowered position, or
2. No traffic is approaching or stopped at the crossing, or
3. A qualified employee, other than a crewmember, with the ability to communicate with trains is stationed at the crossing to warn traffic.

## LOCOMOTIVE BELLS AND LIGHTS

### 72. Engine Bell

The engine bell must be rung when an engine is about to move, except after momentary stops in continuous switch movements. It must also be rung while approaching and passing public crossings at grade, employees or other persons on or near the track, trains standing on adjacent tracks, stations, and when passing through tunnels. Unnecessary use of the bell is prohibited.

### 73. Locomotive Headlights

- (a) The headlight facing the direction of movement on every train and engine must be displayed brightly by day and night.

The headlight must be dimmed:

1. While standing or passing through yards where other engines are working.
2. When approaching terminals.
3. When standing or when approaching another train operating in the opposite direction in multiple track territory.

**EXCEPTION:** When approaching or passing over public crossings at grade, the headlight must not be dimmed.

- (b) Engines in yard service must display the headlight to the front and rear, by day and by night. The headlight on the end coupled to cars may be extinguished.

- (c) If all headlight bulbs fail en route, the Engineer must take the following actions:

1. Notify the Train Dispatcher as soon as practical.
2. Ring the bell continuously.
3. Sound the engine horn frequently.
4. Approach all public crossings at grade prepared to stop. Train may proceed over crossing not exceeding 20 MPH. Speed applies to head end only.
5. Reduce speed at other locations when required by the prevailing conditions, not exceeding 50 MPH at night.

**EXCEPTION:** These restrictions do not apply when the train has operable auxiliary lights.

## **74. Auxiliary Lights**

The leading end of leading locomotives that operate over public crossings at grade at speeds greater than 20 MPH must be equipped with auxiliary lights. Auxiliary lights consist of:

- (a) Two ditch lights (auxiliary lights on steady).
- (b) Two crossing lights (auxiliary lights alternately flashing).
- (c) One oscillating light (auxiliary light that moves in a circular or figure 8 pattern).

## **75. Operative Auxiliary Lights**

Auxiliary lights are considered operative when they illuminate after the engine horn and/or bell is sounded or the auxiliary light switch is activated.

## **76. Operational Auxiliary Lights**

Auxiliary lights must be operational before the engine leaves its initial terminal, and must be displayed when the locomotive is approaching and operating over public crossings at grade.

## **77. One Pair of Auxiliary Lights Fail En Route**

If one of a pair of auxiliary lights fails en route, the train may continue at Authorized Speed, but the defective auxiliary light must be repaired no later than the next calendar day inspection.

## **78. All Auxiliary Lights Fail En Route**

If all auxiliary lights fail en route, the train must not exceed 20 MPH while the leading end of the train is operating over public crossing at grade, and the auxiliary light(s) must be repaired at the next forward repair point.

## **79. Auxiliary Lights When Employees Are Mounting**

Auxiliary lights must be turned off when an employee is to mount the leading end of the locomotive.

## **80. Situations to Turn Off Auxiliary Lights**

The Engineer may turn off the auxiliary lights when operating in fog or falling snow and vision is impaired by reflection of the auxiliary lights.

## ***END OF TRAIN MARKERS***

### **81. Requirements for Markers**

Each train occupying or operating on a main track outside yard limits will display a marker on the rear to indicate the end of the train.

### **82. Flashing Electric Markers**

Continuous or flashing electric marker will be lighted from 1 hour before sunset until 1 hour after sunrise, and during all other hours when weather conditions restrict visibility to less than half a mile.

### **83. Red Reflectorized Disc or a Red Flag Marker**

A red reflectorized disc or a red flag will be displayed at the rear of a train as the marker when:

- (a) Electric marker is not required to be lighted.
- (b) Rear car is a bad order that can be handled only on rear for movement to nearest repair point.
- (c) A portion of the train is disabled and a portable electric marker is not available for display on the rear of the remaining portion for movement to the next terminal.
- (d) Electric marker becomes inoperative en route, but red reflectorized disc or red flag may be displayed in lieu of lighted electric marker only to the next forward point where the electric marker can be repaired or replaced.
- (e) If a rear electric marker fails en route, the crew must promptly notify the Train Dispatcher.

### **84. Marker Examination Requirements**

When a lighted marker is required it must be examined and in operating condition at initial terminal and at each crew change and the Engineer must be given the result of this check. The examination will be conducted visually, or by radio telemetry from the locomotive cab. A marker that is not functioning must be reported promptly to the proper authority.

## **85. Marker for Light Engine or Engine on the Rear of a Train**

When a light engine moves as a train or an engine is on rear of a train, the rear headlight must be illuminated on low beam as a marker.



# MOVEMENT OF TRAINS AND ENGINES

## YARD LIMITS – MAIN TRACK

### 93. Main Track within Yard Limits

- (a) Yard Limits are designated in the Timetable, and indicated by “Yard Limit” signs.
- (b) All train and engine movements within Yard Limits must be made at Restricted Speed unless operating on a block signal indication that is more favorable than an Approach.

The following signal rules require operating at Restricted Speed within Yard Limits:

Approach (314, 331, 346)

Diverging Approach (333, 347)

Medium Approach and Slow Approach (315, 317, 335)

Restricting (318, 336, 348)

Approach Restricted and Diverging Approach  
Restricted (344, 345)

- (c) A train or engine must not move against the current of traffic within Yard Limits until provision has been made for the protection of the movement, and movement must be made at Restricted Speed.

## **GENERAL**

### **94. Responsibility for Safety of the Train**

- (a) The Conductor, Engineer and pilot are jointly responsible for safety of the train and engine and for observance of the rules. Under conditions not provided for by the rules, they must take every precaution for protection. When necessary, they must instruct members of their crew as to proper performance of duties.
- (b) Other members of the crew must call attention of Conductor or Engineer immediately to any apparent failure to observe requirements of rules, Timetable, mandatory directives, messages or other instructions.
- (c) If the Engineer fails to control movement in accordance with signals or other conditions, crewmembers must communicate with him/her at once. If he then fails to immediately control speed properly they must take necessary action to stop the train.
- (d) When a train or yard movement has in its consist a crane, spreader, ditcher, or other equipment, the operation of which may foul adjacent tracks, such work must not be attempted until protection has been provided against approaching movements on all tracks that may be fouled.

### **95. Starting**

A train or engine must not start until the proper signal is given.

### **96. Return Movement**

When engines or cars are detached from a train, precautions must be taken to prevent damage to equipment when re-coupling. Return movement must be made at Restricted Speed. A crewmember must be stationed at, on, or ahead of the leading end of the return movement to protect against the detached portion of the train.

### **97. Movement of Single Light Locomotive**

A single light locomotive must:

- (a) Not enter a Rail-highway grade crossing equipped with automatic crossing warning device until:

- Warning lights have been activated at least 20 seconds and gates, if equipped, have been in the horizontal position for at least five (5) seconds, or
- Crossing is protected by flag.

This restriction also applies to a reverse movement over the crossing.

- (b)** In signaled territory, be provided protection against opposing and following movements in the same block at all times from the Train Dispatcher

## **98. Helper/Pusher Service**

- (a)** A stop to receive a helper/pusher must, if possible, be made at a point where the Engineer on the train being assisted can see the next signal ahead that governs his/her movement.
- (b)** The location for detaching helper/pusher locomotive(s) from the train being assisted must be approved by the Train Dispatcher and must not be altered.
- (c)** Helper/pusher locomotive(s) cut off at the completion of helper/pusher service will be considered as having no assigned direction until authorized by the Train Dispatcher. The assigned direction may be authorized in advance of detaching from the train being assisted.

*Revised 7/21/16*

## **99. Precautions against Unusual Conditions**

Trains must be fully protected against any known condition that may interfere with safe passage.

- (a)** If an event occurs or conditions are found that may interfere with the safe passage of trains and no protection has been provided, employees must immediately attempt to stop trains by radio communication.
1. If a crewmember believes the train has passed over a dangerous defect, the train must be stopped at once and inspected.

2. When severe storm, dense fog, high water, fire or any other condition threatens safe movement speed must be reduced on curves and wherever conditions require.
- (b) A prompt report must be made to the Train Dispatcher and protection provided.

## **100. Approaching the End of Two or More Tracks, Railroad Crossings at Grade, and Drawbridges**

- (a) Trains and engines must approach the following locations prepared to stop unless the switches are properly lined, the signals authorize movement to proceed, and the track is clear:
1. The end of two or more main tracks.
  2. Railroad crossings at grade.
  3. Drawbridges.

Where required by rule or by law, trains and engines must stop.

- (b) Where avoidable, cars must not block a junction, end of two tracks, or railroad crossing at grade when the engine is detached.
- (c) Engines or cars must not be detached and left standing neither entirely between the opposing home signals governing movement over a railroad crossing at grade nor entirely between derails protecting such crossing.

## **101. Protection against Following Trains**

Protection against following trains is not required when:

- (a) Rear of train is within signaled territory and is protected by at least 2 block signals.
- (b) Rear of train is protected by an absolute block.
- (c) Rear of train is within controlled point/interlocking limits.
- (d) Timetable or Track Authority specifies that protection is not required.

## **102. Permanent Signs**

- (a) Numbers on speed limit signs, where provided, indicate the maximum speed on curves. When used on single track, speed limit

signs are located to the right of the track approaching the restricted curve(s). Where movements operate in either direction on two or more tracks, speed limit signs are also located to the left.

- (b)** Where provided, a number plate below a speed limit sign indicates the number of curves that it governs.
- (c)** The speed restriction indicated by a speed limit sign must be observed until the rear of the train passes the point of restriction that governs opposing trains. If a more restrictive sign intervenes, its indication also must be observed.

### **103. Safe Movement of Trains and Engines – Slow Order Conditions**

- 1.** When an employee encounters rough track, a track defect, a switch (to include a spring switch with the switch points not fitting up properly against the rail), or a condition that could interfere with the safe passage of a train or engine, the employee must promptly report the defect or condition to the Train Dispatcher.

The Train Dispatcher will issue a 10 MPH slow order to trains operating over the affected track section. The slow order will remain in effect until the track is inspected by a qualified employee.

- 2.** When a train is stopped by an emergency brake application, the Dispatcher must be immediately notified. If the emergency brake application:
  - (a)** Does not result in a train separation (train is intact), the Train Dispatcher will issue a slow order restricting trains over the affected track section to one-half (1/2) the maximum authorized speed for any train at that location but not to exceed 30 MPH. The slow order will remain in effect until the next train passes without incident, or until the track is inspected and a qualified MW&S employee authorizes a higher speed.
  - (b)** Results in a train separation (i.e. train uncoupling, broken knuckle/coupler), the Train Dispatcher will issue a slow order restricting trains operating over the affected track section to one-half (1/2) the maximum authorized speed for any train at that location but not to exceed 30 MPH. The slow order will remain in effect until the track is inspected and a qualified MW&S employee authorizes a higher speed.

**NOTE:** The requirements of Paragraph 2, sub-paragraphs (a) and (b), do not apply when the train separation occurs while pulling from a stop and the train has moved (1) one train length or less.

*Revised 6/25/15*

3. Slow orders will be issued in 5 MPH increments with restrictions falling between 5 MPH increments being issued at the next lowest number. Example: If maximum authorized speed for any train at the point where the emergency brake application occurs is 25 MPH, the slow order will be issued as a 10 MPH restricting

*Revised 6/25/15*

4. If a speed restriction requires the passage of one tonnage train in order to remove the restriction, one or more trains with a total accumulated tonnage meeting or exceeding 5,000 tons will meet the necessary requirements.

If a speed restriction requires the passage of two tonnage trains in order to remove the restriction, one or more trains with a total accumulated tonnage meeting or exceeding 10,000 tons will meet the necessary requirements. *Revised 3/3/17*

## **104. Restricted Equipment**

**(a)** Train and yard crews must not move cars:

- Determined unsafe for movement
- Loaded over capacity
- Beyond designated height and weight limits
- With lading improperly distributed or secured

**(b)** Proper authority must be notified of any of these conditions

**(c)** Cars or other equipment that would restrict the movement must not be placed in a train except as authorized. Conductor and Engineer of the train must be informed of restricted equipment.

**(d)** The Conductor must inform the Engineer of equipment or cars that restrict movement of the train or require special handling.

## **105. Stopping on Bridges**

When the locomotive consist of a train stops on a bridge, the Engineer will inform all other crewmembers of the fact and advise them to take caution when dismounting.

# **EMERGENCY BRAKE APPLICATIONS**

## **110. Emergency Brake Application – Warning to Approaching Trains on Adjacent Tracks**

When a train is stopped by an emergency brake application, a crew-member must:

- (a)** Immediately announce by radio:
  - train (identification) has brakes in emergency
  - direction and milepost location
  - track designation (if in multiple track territory)
- (b)** Promptly report this information to the Train Dispatcher.
- (c)** Repeat this warning as necessary until protection is provided by the Train Dispatcher or until it is known that adjacent tracks are not obstructed.

## **111. Trains on Adjacent Tracks**

All trains notified that a train is in emergency on an adjacent track must operate at Restricted Speed while passing the train until it is determined that the track is clear.

## **112. Responsibility of the Train Dispatcher after an Emergency Brake Application**

The Train Dispatcher will:

- (a)** Provide protection on adjacent controlled track(s) until advised there is no obstruction.
- (b)** If the adjacent track(s) is controlled by a foreign railroad, immediately notify that railroad and obtain protection.

Trains may be authorized to pass the train in emergency at Restricted Speed until advised there is no obstruction. This authorization must include the identity and location of the train in emergency.

## **113. Train Inspection after an Emergency Brake Application**

- (a)** When a train is stopped by an emergency brake application, a visual inspection must be made of the train to ensure all wheels are on the rail, all equipment is in safe operating condition, and that the train is complete, as indicated by display of rear-end marker, before proceeding.



If the problem is a repairable break in the train line that did not result in a train separation (i.e., train uncoupling, broken knuckle, etc.) and brake pipe pressure is being restored at the rear of the train following repair, trains relieved of inspection in paragraph 3 below may proceed. If excessive power is required to start or keep the train moving, movement must be stopped immediately and the cause determined.

- (b)** If physical characteristics prevent a complete visual inspection and brake pipe pressure is being restored at the rear of the train, inspect as much of the train as possible. The remaining portion of the train may then be moved, not exceeding 5 MPH and under direct observation of a crewmember, a distance necessary to complete the inspection. If excessive power is required to start or keep the train moving, movement must be stopped immediately and the cause determined.

If brake pipe pressure cannot be restored at the rear of the train, arrangements must be made to determine cause before moving.

- (c)** The following trains are relieved of visual inspection required by an emergency brake application when the brake pipe pressure is being restored at the rear of the train:
- Solid loaded bulk commodity trains, or
  - ECP trains operating in “RUN” mode, or
  - Any train where the emergency brake application occurred at a speed above 25 MPH, or
  - Any train that is 5,000 tons or less

**EXCEPTION:** A visual inspection of the above trains is required if:

- the train is a key train, or
- the emergency brake application occurred with any portion of the train moving through a turnout or a crossover, or
- the train has 200 cars or more and is operating with pusher or distributive power (DP) in power mode

The Train Dispatcher must be notified of the inspection results.

# **REVERSE MOVEMENTS ON CONTROLLED TRACK**

## **115. Reverse Movements on Controlled Track**

A reverse movement is a movement opposite the direction previously authorized.

**(a)** Reverse movement by a train or engine must be:

- authorized by the Control Station
- properly protected by a qualified employee

**(b)** Reverse movement within the limits of the same block in **Rule 251** or **Rule 261** territory:

When verbally authorized by the Train Dispatcher, a train or engine may make a reverse movement:

- at Restricted Speed

**NOTE:** Train Dispatcher must be notified when the reverse move is complete.

**(c)** Reverse movement beyond limits of the block may be made

1. Where **Rule 251** is in effect:

- when properly authorized by a Form of Track Authority to operate against the current of traffic

2. Where **Rule 261** is in effect:

- when authorized by a Form of Track Authority, or
- when verbally authorized by the Train Dispatcher and operated at Restricted Speed until governed by a more favorable signal

3. Where **Rule 271** is in effect:

- when authorized by a Form of Track Authority, and
- when operated at Restricted Speed until governed by a more favorable signal

## **116. Train Dispatcher Authorizing Reverse Movements**

**(a)** Before granting permission for a train or engine to make a reverse movement the Train Dispatcher must:

1. Determine the track to be used is clear and will remain clear of opposing or following movements.

2. Apply blocking devices to protect against opposing movements.
  3. Code signals governing opposing movements to Stop.
- (b) Within the limits of the same block verbal authority must be granted for the movement.
- (c) Beyond limits of the block
1. Where **Rule 251** is in effect:
    - issue Track Authority for movement against the current of traffic
  2. Where **Rule 261** is in effect:
    - issue a Track Authority Form
    - grant movement verbal authority
  3. Where **Rule 271** is in effect:
    - issue a Track Authority Form

## **MOVEMENTS OVER HIGHWAY – RAIL GRADE CROSSINGS**

### **120. Cars Not Headed by an Occupied Engine over a Highway – Rail Grade Crossing**

- (a) When cars not headed by an occupied engine are moved over a:
- public crossing
  - private crossing located outside the physical confines of a rail yard
  - pedestrian crossing located outside the physical confines of a rail yard
  - yard access crossing

A member of the crew must be on the ground at the crossing to warn traffic until the leading end has passed over the crossing.

Rail movements over the crossing will be made only on proper signal from the employee.

- (b) These actions are not required if the crossing is clear, and:
1. Crossing gates are in the fully lowered position, and are not known to be malfunctioning; or
  2. The crossing is equipped with flashing lights, crossbucks, or stop signs and it is clearly seen that no traffic is approaching or stopped at the crossing, and the leading end of the movement over the crossing does not exceed 15 MPH; or
  3. A qualified employee, other than a crewmember, with the ability to communicate with trains is stationed at the crossing to warn traffic; or
  4. The crossing has been rendered inaccessible to highway motor vehicles.

*Revised 12/2/16*

### **121. Clearing Crossings**

- (a) Trains, engines, or cars when left unattended must clear crossings and crossing signal circuits. When practicable the equipment must be at least 300 feet from public or private crossing.
- (b) Public crossings must not be obstructed unnecessarily.

## 122. Adjacent Tracks at Crossings

When either end of a train stands near a grade crossing or train has been cut for a crossing, a crewmember when available must afford warning signals to persons or operators of motor vehicles against movements approaching on adjacent tracks.

## 123. Approaching Crossings with Automatic Warning Devices

- (a) When a train or engine has activated an automatic crossing warning device and is delayed, the movement will not enter the crossing until:
1. Warning lights have been activated at least 20 seconds and gates, if equipped, have been in horizontal position at least 5 seconds, or
  2. Crossing is protected by flag.

This restriction also applies to either a reverse movement over the crossing or a movement approaching at Restricted Speed.

- (b) On running tracks, yard tracks, and industrial tracks, trains and engines must approach crossings equipped with automatic warning devices prepared to stop. If warning device does not activate, on ground warning must be provided before proceeding over crossing.
- (c) When conditions are present that will prevent effective shunting of warning devices, crossing must be protected in the same manner as an “activation failure.”
- (d) Sudden increases in the speed of any train movement in the approaches to signalized highway grade crossings are prohibited.

## 124. Manually Raising Crossing Gate Arms

Train and Engine Service employees are prohibited from manually raising grade crossing gate arms that are in a horizontal position to permit the passage of highway traffic.

**EXCEPTION:** In an emergency any employee, including Train and Engine Service employees, may raise crossing gate arms to permit passage of emergency response vehicles when it is known by the employee(s) the vehicle can cross safely.

When gates are raised beyond 45 degrees above horizontal, the gate mechanism will automatically cycle downward.

## **125. Highway – Rail Grade Crossing Warning System Malfunctions**

Upon receipt of a report of warning system malfunction involving an activation failure, false or partial activation, the employee receiving such information shall promptly initiate efforts to warn highway users and railroad employees at the crossing by taking the following actions:

- (a) Prior to any train's arrival at the crossing, notify the train crew of the report of activation failure, false or partial activation, and notify any other railroads operating over the crossing.
- (b) Notify the law enforcement agency having jurisdiction over the crossing, or railroad police capable of responding and controlling vehicular traffic.
- (c) Provide for alternative methods of actively warning highway users of approaching trains, consistent with the following requirements:
  - 1. If an appropriately equipped flagger provides warning for each direction of highway traffic, trains may proceed through the crossing at authorized speed.
  - 2. If at least 1 uniformed law enforcement officer (including a railroad police officer) provides warning to highway traffic at the crossing, trains may proceed through the crossing at authorized speed.

Crossing warning whistle signal will be sounded as prescribed by **Rule 70(f)**, regardless of State laws or ordinances to the contrary.

## **126. Activation Failure**

- (a) If an appropriately equipped flagger provides warning for highway traffic, but there is not at least 1 flagger providing warning for each direction of highway traffic, trains may proceed with caution through the crossing at a speed not exceeding 15 MPH. Authorized speed may be resumed after the leading end of the movement has passed through the crossing.

- (b) If there is not an appropriately equipped flagger or uniformed law enforcement officer providing warning to highway traffic at the crossing, each train must stop before entering the crossing and permit a crewmember to dismount to flag highway traffic to a stop. The locomotive may then proceed through the crossing, and the flagging crew member may re-board the locomotive before the remainder of the train proceeds through the crossing. In the case of a shoving move, a crewmember shall be on the ground to flag the train through the crossing.

## **127. False / Partial Activation**

- (a) If there is not an appropriately equipped flagger providing warning for each direction of highway traffic, or if there is not at least 1 uniformed law enforcement officer providing warning, trains with the locomotive or caboose leading may proceed with caution through the crossing at a speed not exceeding 15 MPH. Authorized speed may be resumed after the leading end of the movement has passed through the crossing. In the case of a shoving move, a crewmember shall be on the ground to flag the train through the crossing.
- (b) After report of a “False Activation” the warning system may be temporarily taken out of service if the alternative methods of protection prescribed for “Activation Failure” are observed.

## Alternate Methods of Protection Matrix

	Flaggers for each direction of traffic	Police Officer present	Flagger present, but not one for each direction of traffic	No flagger/ No police
False or Partial Activation	Normal Speed	Normal Speed	Proceed with caution — maximum speed of 15 mph until leading end is over crossing	Proceed with caution — maximum speed of 15 mph until leading end is over crossing
Activation Failure	Normal Speed	Normal Speed	Proceed with caution — maximum speed of 15 mph until leading end is over crossing	Stop: Crewmember flag traffic and Reboard

### 128. Traffic at Crossings

Train crewmembers will report changes in highway traffic on specific crossings.

Grade crossings should be reported when highway traffic has changed, such as increased heavy truck movement, new or more school buses, trucks hauling a dangerous commodity, or anything that may jeopardize safe train movement.

Each report should contain the name of the District, milepost and crossing, if possible, and should be forwarded to the Chief Dispatcher's Office.

### 129. Near Miss

When a Near Miss is encountered, a crewmember must promptly contact the Train Dispatcher and provide relevant information, which may include milepost, road name, DOT Crossing Number, vehicle make / model / color, commercial vehicle name, license plate number, truck / trailer number, direction of travel, description of violation, etc.

The Train Dispatcher will promptly notify the NS Police Communications Center (NS PCC).



# TRAIN INSPECTIONS

## 140. Inspecting Trains

(a) Employees must inspect passing trains for their entire length for defects such as sticking brakes, hot journals, broken or loose wheels, brake rigging down, loads shifted, or any other defect. Inspection on both sides is required when two or more employees can safely position themselves in advance.

**EXCEPTION:** During train meets, crew members must inspect passing trains from either inside the locomotive cab or from a safe ground location. When performing the inspection from the ground, employees must dismount the locomotive on the field side away from the adjacent track, if possible. Crewmembers are not required to cross tracks to inspect a passing train.

(b) If any defect is observed, prompt action must be taken to notify the crew. If the crew cannot be notified, the Train Dispatcher must be notified as quickly as possible.

(c) After the train passes, the employee performing the inspection must notify the crew by radio of the condition of their train.

(d) Crew members must frequently observe their train for defects and maintain a vigilant lookout along the right-of-way for conditions affecting train movement. If a dangerous condition is observed, prompt action must be taken to notify the Train Dispatcher and to warn any approaching train.

## 141. Equipment with Defects

Conductors must if possible remedy defects in their equipment, and must remove from the consist any cars that are unsafe to run. They must report all defective brakes, hot boxes or other defects, as well as repairs made between terminals.

They must comply with instructions for reporting materials applied to cars and disposition of defective parts.

Conductors must not move cars bearing Bad Order tags without proper authority.

Cars bearing Home Shop tags must be moved in accordance with any restrictions shown.

## 142. Setting off Cars on Line-of-Road

- (a) Conductors must not permit cars or engines to be set out en route on any track not having derail protection, without obtaining authority, in each instance, of the Train Dispatcher.
- (b) Cars must not be set off short of a waybill destination or a designated terminal except in an emergency or unless authorized by proper authority.
- (c) When a car is set off because of a hot journal, it must be determined by inspection that:
  - 1. The car can be safely moved to a set-off location.
  - 2. Any grease seeping from a roller bearing has not been ignited.
  - 3. Fire has not spread to the underside of the car floor or elsewhere.
- (d) The Train Dispatcher must be notified immediately if fire is observed and must be advised the extent to which it has spread beyond the roller bearing.

**NOTE:** If necessary, a fire extinguisher from the locomotive may be used to put out the fire.

- (e) When any car is set off in an emergency, the Train Dispatcher must be notified of:
  - car initial and number
  - contents
  - destination
  - location of the car and waybill
  - the reason for setting out the car

Where applicable, the Conductor must specify the location of defects on the car by “A” end or “B” end and “left” or “right” side, etc.

# **DEFECTIVE EQUIPMENT DETECTORS**

## **145. Defective Equipment Detectors**

When approaching, passing, or departing detector locations, crewmembers must have their radios on the appropriate road channel and must be alert for detector radio transmissions. All employees in the vicinity of detector locations must keep radio transmissions to an absolute minimum to avoid interference with detector radio messages.

When a detector announces one or more defects to a passing train, the train must be stopped and inspected for excessive bearing heat, dragging equipment, sticking brakes, over dimension, or sliding wheels, as applicable.

A crewmember must immediately notify the Train Dispatcher when the movement of their train is affected by a defective equipment detector alarm and must provide the Train Dispatcher with timely status updates, as applicable.

Additionally, a crewmember must notify the Wayside Detector Help Desk (DTMF Code 128) of the defective equipment detector alarm. The Help Desk will provide additional information such as car number and wheel position, if available.

When an inspection is required:

- A thorough inspection must be made of the cars indicated as being defective. Except when relieved by the Help Desk, both sides of the cars must be inspected.
- The crewmember must take the necessary tools and supplies. Crews in road service must have a 200 Degree Temperature indicator and a hand-held counter accessible while on duty. The hand-held counter must be used to ensure the proper axle is inspected. A copy of the train consist must not be used to locate an axle indicated as defective.

Following the train inspection, a crewmember must notify the Train Dispatcher and the Help Desk of the inspection results as quickly as possible, even if no exceptions were taken.

## 146. Train Inspection – “No Defect” Message

- (a) When no defects have been detected, the exit radio message will be:
- “NS detector, milepost location, identification of track to which message is applicable (in multiple track territory),” and followed by “NO DEFECTS.”
- (b) If train speed drops below 8 mph while passing over the detector, and a “NO DEFECTS” message is received, the train must be stopped and a roll-by inspection of one (1) side of the train must be performed at a speed not exceeding 10 MPH.
- (c) If a “NO DEFECTS” message is received before the rear of train has cleared the detector, the train may proceed in accordance with **Rule 152**.

## 147. Train Inspection – Defect Message

- (a) When a train is occupying a detector and a defect has been detected, an automatic radio transmission as described below will occur:
- A warning alarm and/or a “TONE” will indicate that a defect has been detected.
  - A message stating “CRITICAL ALARM” will indicate that an excessively hot journal or dragging equipment defect has been detected.
- (b) When a defect message is received, the train must immediately reduce speed to not less than 8 MPH until the rear of the train clears the detector at which point the train must be stopped for inspection. **EXCEPTION:** The train must be immediately stopped for inspection, consistent with safe train handling procedures anytime a “CRITICAL ALARM” is received for detection of a hot bearing (hot box) or a dragging equipment defect.
- (c) When the rear has cleared the detector, or a detector has timed out due to lack of movement, a radio message will be transmitted to indicate nature of any defects and its location in the train. The location will be given by axle count, counting from the first axle in the locomotive consist. The detector will identify track to which message is applicable in multiple track territory.

- (d) If train speed drops below 8 mph while passing over the detector, and a “DEFECT” message is received, the train must be stopped and all cars following the last car indicated as being defective must be inspected.
- (e) If 3 or more of the same type of defects are reported, the Help Desk must be contacted for a complete listing of defect indications. If the Help Desk is not able to provide all defect data, those defect locations noted in the audible alarm must be inspected and the balance of the train behind the last reported defect must be inspected.
- (f) The inspection results must be provided to the Help Desk prior to the crewmember departing the car location. If no defect is found, the Conductor must advise the proper authority at the final terminal so the car(s) can be inspected by the Mechanical Department.

#### **148. Hotbox Detectors**

- (a) When authorized by the Help Desk, after stopping, a roll by inspection may be performed on the side of the train indicated as having defects at a speed not exceeding 10 MPH. The person making the inspection must visually monitor the train during the roll-by inspection for any defects, and must stop the train and inspect the cars identified as being defective.
- (b) A crewmember must use a temperature indicator to determine if a bearing is overheated and car cannot continue in service as follows:
  - Stroke the outside surface of the top of the journal box or the lower half of the cup of the roller bearing
  - Stroke the top of the inboard surface of the adapter on Amfleet cars equipped with inboard bearings

If a liquid smear results, obtain instructions from the Train Dispatcher. The temperature indicator should be used only on the reported bearing or if there is evidence of an overheated bearing.

- (c) If no apparent defects are found, 20-axles ahead and behind of the designated car(s) must be thoroughly inspected on the side of the equipment indicated as having a defect.

## 149. Hot Wheel Detectors

- (a) When operating in single track territory, a train receiving a Hot Wheel defect alarm may proceed at a speed not to exceed 30 MPH to the next siding, double track, or yard location where the train must be stopped and inspected, provided:
1. Train is not a Key Train or Passenger Train.
  2. No erratic operation of the train is detected by the train crew.
  3. The Train Dispatcher is immediately notified of the Hot Wheel defect alarm and a job briefing held to determine the location where the train is to be stopped.
- (b) When operating in double track territory, a train receiving a Hot Wheel defect alarm must be stopped and inspected.
- (c) After stopping the train, a roll-by inspection may be performed at a speed not exceeding 10 MPH. Prior to making the roll-by inspection, the Engineer must make a full service application of the air brakes, allowing sufficient time for a complete set and equalization of the brake system before initiating a release. The set and release is required to ensure the release of any sticking brakes caused by overcharge or incomplete release conditions.

The person making the inspection must visually monitor the train during the roll-by inspection for any defects, and must stop the train and inspect the axle(s) identified as defective and determine that the brake is released, the hand brake is released, and the retainer is in the proper position, if applicable. If still not released, the air brake may be cut out.

## 150. Dragging Equipment Detectors

At Dragging Equipment Detector locations that do not provide an axle location for the defect, the entire train must be inspected.

## 151. High Car and Clearance Detectors

- (a) If there is no transmission received after passing over a high car or clearance detector location or after a “DETECTOR NOT WORKING” or “SYSTEM FAILURE” message is received, the train must not pass through obstructions such as height restricted bridges, tunnels, etc., until inspection is made.

- (b) If a defect is detected at a radio alarm High Car Detector or Clearance Detector, in addition to checking the location specified, 2 cars (or 2 platforms on articulated equipment) ahead and behind the reported location must also be inspected, even if a defect is found at the reported location.

## 152. Failure Message Received

- (a) A train receiving a failure message (e.g. “Analyzer Failure,” “System Failure,” “Detector Malfunction,” or “System Not Working”) may proceed, in accordance with existing authority, at a speed not to exceed 30 MPH to the next detector provided:
  1. Train is not a Key Train or Passenger Train.
  2. No erratic operation of the train is detected by the train crew.
  3. Train Dispatcher is notified of detector failure.
  4. The previous detector over which the train passed detected “NO DEFECTS”.
- (b) A train receiving a failure message at the first detector after departing a yard, or on 2 consecutive detectors, must be stopped and a roll-by inspection of one (1) side of the train must be performed at a speed not exceeding 10 MPH.
- (c) A train receiving a failure message at the last detector prior to entering a yard must notify the Yardmaster, or other designated authority, to ensure a proper inspection can be made.

## 153. No Message Received

If a train passes over a detector and no message is received:

- (a) The crew must immediately request a repeat of the detector voice message by entering 001 on the radio keypad and comply with the retransmitted detector message.

**NOTE:** Certain detectors are not equipped with the retransmission feature.

- (b) If a retransmission detector message is unavailable:

1. The train may proceed, in accordance with existing authority, at a speed not to exceed 30 MPH and the crew must

immediately notify the train dispatcher and contact the Wayside Detector Help Desk to obtain available information from the detector and comply with the information provided by the Help Desk.

2. If the Wayside Detector Help Desk is unable to provide further information to a train after receiving no message from a detector, the train must proceed in accordance with **Operating Rule 152 “Failure Message Received”**. If a failure message is received, Key Trains and Passenger Trains must be stopped and inspected. *Revised 3/16/17*

## 154. Conditions When a Visual Inspection Is Not Required

- (a) The Help Desk or the Train Dispatcher may relieve a crew from inspecting their train for Hot Box or Hot Wheel defect alarms when information is available confirming it is safe to proceed. Trains relieved of inspection may proceed, in accordance with existing authority, at a speed not to exceed 30 MPH to the next detector or to the location where the car is to be set out, if applicable. Trains relieved of inspection at the last detector prior to entering a yard must notify the Yardmaster, or other designated authority to ensure a proper inspection is made.
- (b) If the detector is known to be defective, the Train Dispatcher may authorize a roll-by inspection, not exceeding 30 MPH, of both sides of the train by qualified persons within the designated acknowledgement point (milepost locations designated in Timetable) or a train length plus 20 car lengths beyond the detector when a milepost is not designated.

**EXCEPTION:** All Key Trains must stop immediately and be inspected with any detector failure.

## 155. Consecutive Detector Stops

When a hot journal is indicated for the same journal by 2 consecutive detectors or by 2 of 3 successive detectors, the car is to be set out. Additionally, any time a car has a high reading on 3 detectors over a division, the car is to be set out. A malfunctioning detector will not be considered as one of the consecutive or successive detectors except



for any cars known to be correctly scanned by that detector. A car will not be set out if it can be determined, positively, that sticking brakes caused the high readings and it is known that the car can be moved safely.

These instructions apply to trains traversing territories governed by adjoining Train Dispatchers. Information on detector stops must be promptly conveyed between Train Dispatchers.

## 156. Stress State Detectors

Stress State Detectors (SSD) measure various stress levels that occur at the rail to wheel interface point as a train passes over the detector. These measurements include:

- Impact a rail wheel has on the track structure
- Imbalance loads resulting from improper loading and/or shifted loads

### (a) Radio Messages:

1. Stress State Detectors are equipped to transmit via radio on the designated road channel either a “Non-Critical” or “Critical” alarm message when a defect is detected.
  - **Non-Critical** — NS SSD MP (milepost location) Track (designation). (Number of alarms detected) alarms detected. Contact Train Dispatcher.
  - **Critical** — Critical Alarm, Critical Alarm, Critical Alarm. NS SSD MP (milepost location) Track (designation). (Number of alarms detected) alarms detected. Contact Train Dispatcher.
2. “NO DEFECT” Message

If the SSD does not detect any alarm conditions, the detector will announce twice via radio on the designated road channel the following automatic message:

NS SSD MP (milepost location) Track (designation) —  
NO DEFECT

## **(b) Detector Alarms**

1. When a Stress State Detector transmits via radio an alarm message (“Non-Critical” or “Critical”), the train:

- **Non-Critical**

May continue without stopping, not exceeding 30 MPH to the next forward mechanical repair location or other location designated by Division timetable instructions, as determined by Train Dispatcher where equipment must be set out.

- **Critical**

Must be stopped for inspection as soon as possible consistent with safe train handling procedures. If no defect(s) is found upon inspection, the train may proceed, not exceeding 30 MPH, to a location designated by Division timetable instructions where equipment must be set-out. If a defect(s) is found upon inspection, coordinate with Mechanical Department to make the determination if the equipment is safe to move, including any additional handling restrictions.

2. If the SSD does NOT transmit a message or a message is NOT received, the train must immediately reduce speed, not exceeding 30 MPH. Train crew must promptly notify the Train Dispatcher and Help Desk of the location and failure of the SSD announcement. Unless notified by the Train Dispatcher to stop and inspect a car(s), the train may then proceed at authorized speed without stopping.

The Train Dispatcher must promptly notify the C&S Department of the failure.

## **(c) Inspection**

When an inspection is required, a crewmember must visually inspect the car(s) indicated. Based on the defect type, the following conditions should be inspected for:

1. Wheel Impact

- Flat Spots/Shelled Tread
- Broken/Cracked Wheel
- Tread Build-up

## 2. Imbalanced Load

- Bulging sides, doors, ends, or top chords
- Leaning or Listing
- Springs that are completely compressed on one side and loose on the other side
- A restriction between the wheels and car body
- Lading improperly distributed and/or shifted in open-top cars

### (d) General Instructions

Trains that stop on a SSD or do not maintain a minimum of 15 MPH while passing over the SSD may receive multiple messages. When possible, stopping or reducing speed below 15 MPH should be avoided while passing a SSD. If multiple voice messages are received, the train must handle them as described in Paragraph B.

When a SSD announces any alarm, a crewmember must promptly notify the Train Dispatcher and Help Desk of the alarm type. When a car(s) must be inspected for SSD alarms, a crewmember must provide the Train Dispatcher with the results of the inspection and furnish the following information:

- Train Identification
- Car Initial and Number
- Type of defect
- Location of defect

The Train Dispatcher will determine proper disposition of car(s) based on any inspection results.

*Revised 12/1/2015*

## ***NON-SIGNALLED MAIN TRACK***

### **171. Non-Signaled Track – Mandatory Directive Authorizes Movement**

Where designated by bulletin or special instructions, use of the main track will be authorized by issuance of a Mandatory Directive, under the direction and over the initials of the Train Dispatcher.

### **172. Communicating Station Names**

In **Rule 171** territory, prior to passing the location of each station sign, the Conductor (or a Conductor trainee or trainmen in the absence of the Conductor), will announce by radio the Timetable station name and specify the track designation when operating in multiple track territory.

## **TRAIN MEETS AND PASSES**

### **174. Positive ID at Meeting or Passing Points**

At meeting or passing points in **Rule 171 or 271** territory there must be a positive exchange of identification of trains involved.

The Engineer or Conductor of each train must:

- (a)** Visually identify the lead locomotive number(s) of the train(s) to be met or passed.
- (b)** Establish positive radio contact with the train(s) to be met or passed and verbally communicate lead locomotive number.
- (c)** The Engineer and Conductor of restricted trains must confirm that the lead locomotive number(s) corresponds to locomotive number of the train to be met or passed as indicated on the Track Authority form and record the identity of the passing train in writing on the reverse side of the Track Authority Form.
- (d)** Contact the Train Dispatcher to confirm the identity of the passing train if they cannot establish radio contact.

### **175. Switches at Meeting Points**

When a train that is to hold the main track is first to arrive at meeting point in **Rule 171 or 271** territory, switch must be properly lined for opposing train to enter siding.

### **176. Engineer Requirements at Meeting Points**

The Engineer of a train that is to hold main track at a meeting point must, not less than 1 mile preceding first switch of designated meeting point, call Engineer of opposing train by radio to determine that opposing train has cleared or will clear main track.

### **177. Responsibility for Authorized Limits**

At least 2 miles before reaching a meeting or waiting point, the Conductor must remind the Engineer that the authority of their train to proceed is restricted, and the Engineer must acknowledge. If the Engineer does not prepare to stop short of fouling point, the Conductor must immediately stop the train.

## **178. Conductor's Responsibility – Approaching Slow Orders and Conditional Stop Signs**

The Conductor must remind the Engineer 2 miles in advance of slow orders and Conditional Stop Sign. If the Engineer does not acknowledge, or prepare to comply with such orders, the Conductor must immediately stop the train.

## **179. Communicating Speed of Slow Orders**

A crewmember on the controlling locomotive will communicate by radio the designated speed and milepost location of each slow order at least 2 miles before reaching it. If there are crew members on trailing units and/or caboose, they will acknowledge the transmission.

Example of correct procedures to initiate and acknowledge the radio transmission(s):

“This is Engineer Reid on NS Train 187. We have a 25 MPH slow order on Main 1 at Milepost 179.3, over.”

## **180. Acknowledging Slow Order Information In-Cab**

Employees in the operating compartment of the controlling locomotive will acknowledge among themselves the designated speed and milepost location of each approaching slow order as the same information is transmitted by radio.

# HANDLING SWITCHES AND DERAILS

## 181. Responsibilities; Hand Operated Switches and Derails

The position of a switch or derail being used is the responsibility of the employee handling it. This does not relieve other members of the crew or work group of responsibility if they are in place to observe the positions of switches and derails.

## 182. Operating Switches by Hand

Employees operating switches and derails by hand must visually ensure:

- (a) Switches and derails are properly lined for the movement to be made, and targets, if equipped, correspond with the switch or derail position.
- (b) Switch points fit up properly.
- (c) Each switch and derail is secured by placing lock or hoop in hasp, if equipped.

## 183. Hand Operated Switches Equipped with Electric Locks

Whenever entering the main track or siding from an auxiliary track through a hand-operated switch, permission must be obtained from the Train Dispatcher before switch lock is removed from its keeper. If there is a derail in the route and the main line switch is equipped with an electric lock, the derail is to be left in the derailing position until the electric lock on the main track switch is unlocked.

## 184. Engineering Department Operating Switches

- (a) Engineering Department employees performing work that requires hand-operation of switches on controlled track must be issued protection by Track Authority form.
- (b) Anytime a switch is taken out of service by the Engineering Department, the switch must be spiked or clamped and an approved craft specific lock must be applied. A tag captioned "Switch Out of Service" will also be applied on the lock, latch or handle.

*Revised 11/17/15*

**EXCEPTION:** Spiking or clamping, and applying a “Switch Out of Service” tag is not required for RWP protection provided switch is secured with an approved craft specific lock.

- (c) Employees observing a switch that needs to be used but is locked and identified as “Out of Service” must not operate the switch and must contact the proper authority for further instructions.

### **185. Double Checking Switch or Derail Position**

When radio communication is used in connection with switching operations, or with the shoving, backing, or pushing of a train, engine, or other On-Track equipment:

- (a) The employee directing the movement must advise the engineer or RCO of the track name or number and that all switches and derails are properly lined for the intended move.
- (b) The Engineer will repeat this information and require the employee to “double check” the position of the switches and derails.

The Engineer must not begin the movement until confirmation is received from the employee directing the movement that the position of the switches and derails has been “double checked.”

### **186. Lining and Locking Switches and Derails After Use**

Switches and derails must be properly lined and secured after having been used.

**NOTE:** Locks must be tested to assure that they are secured. If a lock is defective or missing, the switch or derail must be secured if practical and report must be made at first opportunity to the Control Station or other proper authority.

### **187. Operating Over a Switch**

Switches must not be operated while engines, cars or On-Track equipment are fouling the switch, or standing or moving over the switch.



## **188. Fouling or Entering a Track**

- (a)** A train, engine or On-Track equipment must not foul a track until switches and derails connected with the movement are properly lined.
- (b)** When a locomotive, car or On-Track equipment enters a track through a hand-operated switch, the switch must not be lined away from the track until the equipment has passed the clearance point.

## **189. Switches – Line of Road and Industry Tracks**

Crews picking up on line-of-road and from industry tracks must know that switches occupied by the standing cars are properly lined and latched (when switches are equipped with latches) for the movement to be made.

No car or engine is to be moved over a track when dirt or debris covers the rail and the top of the rail is not visible. If there is any doubt, do not use the track and notify proper authority so the condition can be corrected.

# **MAIN TRACK, DUAL CONTROL, AND POWER SWITCHES**

## **190. Position of Main Track and Siding Switches**

- (a) The normal position for a main track switch is lined and locked for movement on the main track.
- (b) The normal position for a switch connecting any track except main track to a siding is lined and locked for movement on the siding. Such switches must be left in normal position after use.
- (c) Locations where the normal position of a switch is lined for other than the main track or siding are designated in the Timetable.

## **191. Lining Main Track Switch – Employee Position**

- (a) A main track switch must not be lined for the diverging movement of an approaching train or engine unless the employee attending the switch is assured of its identity and knows the movement is to use the turnout.
- (b) Employees must keep away from facing-point switches while trains or engines are approaching or passing. When practicable and safe, they must station themselves on the opposite side of the track from the switch stand.

## **192. Dual Control Switches**

Dual control switches must not be hand-operated until permission is obtained from the Train Dispatcher.

- (a) Dual control switches must be operated as follows:
  1. Selector lever must be taken out of “motor” (or “power”) position and placed in “hand” position and locked, if lock is provided.
  2. Hand-throw lever must be operated until switch points are seen to move with movement of the hand-throw lever. This must be done whether or not the switch points appear to be lined for the desired route.
  3. Switch must then be lined and locked for the route to be used.

4. Selector lever must be left in “hand” position until entire movement has cleared the switch.
  5. Unless instructed otherwise by the Control Station, switches must be restored to “motor” after movement over them is completed.
- (b) When necessary to place a dual-control switch on hand operation to perform switching, the time during which the switch may be used and the limits of the movement must be clearly stated and understood.
1. Selector levers on all switches over which movement is to be made must then be placed in “hand” position and must be left in that position until all movements have been completed.
  2. During the time selector lever is in “hand” position to perform switching, indications of STOP signals may be considered suspended for repeated movements past the signal when authorized by the Control Station. All movements must be made at Restricted Speed.
  3. After switches are restored to power operation, train or engine must not proceed except by proper signal indication or as authorized by the Control Station.

### **193. Power-Operated Switches**

A power-operated switch must not be operated while in power if:

- (a) Train or engine is shown occupying the track circuit over the switch.
- (b) Unit of On-Track equipment is on or closely approaching the switch.

### **194. Authority to Enter Main Track at a Hand-Operated Switch**

Before authorizing a train or engine at a hand-operated switch to:

- (a) Enter main track.
- (b) Enter a controlled or signaled siding.
- (c) Enter siding in **Rule 171 or 271** territory.
- (d) Cross over from one main track to another.

It must be known that there is no conflicting movement.

## 195. Operation of Hand Throw Mainline Switches

In ABS territory, after receiving permission to enter a controlled track, a crewmember must promptly operate the switch, and then wait 5 minutes before starting train movement. If a train is seen or heard approaching on the track to be occupied before the 5 minute period has elapsed, switch must be secured in normal position.

**EXCEPTIONS:** The 5-Minute Wait is not required when:

- (a) Relieved by the Train Dispatcher.
- (b) The switch(es) to be used is opened immediately after an opposing movement has passed and the Train Dispatcher determines there are no other movements approaching the switch from the last interlocking or controlled point.
- (c) The switch(es) to be used is in a block occupied by standing equipment.
- (d) A train or engine is authorized by a “Work Between” Track Authority.
- (e) The switch(es) are equipped with an electric lock.

# **MAIN TRACK SWITCH POSITION**

## **197. Switch Position Confirmation**

Before a train or crew leaves the location where any hand-operated main track switch was operated, all crewmembers shall have verbal communication to confirm the position of the switch. If this information is not provided, the Engineer must request and receive confirmation of the switch position before departing the switch location.

Roadway Workers jointly occupying working limits under the authority of a Roadway Worker in Charge (RWIC) must report the position of any switches operated to the RWIC when reporting clear of the working limits.

## **198. Leaving a Main Track Switch Open**

Except where specifically authorized by the Train Dispatcher or Yardmaster, a main track switch must not be left open for another movement unless in charge of a crewmember of such movement or an employee assigned to handle switches.

## **199. Reporting Clear of Main Track**

Where movements are required to be reported clear of main track, the report must not be made until switch(es) and derail(s), if equipped, have been secured in normal positions.

## **200. Clearing Main Track**

- (a) When a movement clears the main track, the switch must not be restored to normal position until the trailing end is beyond the clearance point or insulated joints.
- (b) A train, engine, or cars on sidings or other tracks must stand clear of insulated joints placed in the track near the clearance point.

## **201. Clearing Main Track at a Hand-Throw Switch**

- (a) When a train or engine clears at a hand-operated switch and the switch has been restored to normal position, “clear” must be reported to the Train Dispatcher by a member of the crew. **EXCEPTION:** Not applicable when train or engine retains exclusive track authority conferred by Track Authority Form.

**(b)** In **Rule 261** territory a train or engine must not clear the main track through a hand-operated switch not equipped with an electric lock unless permanent speed on:

- main track is 20 MPH or less
- siding track is 30 MPH or less

## **202. Switch Position Awareness: Requirements for Hand-Operated Main Track Switches in Non-Signaled Territory and Rule 251 “Track Signaled In One Direction”**

### **(a) Train Crew Communication**

Each time a crewmember changes the position of a hand operated main track switch, the crewmember must communicate with the Engineer while physically at the switch stating the:

- switch name and location, and
- position of the switch (Normal or Reverse)

The Engineer must acknowledge the information before making movement.

### **(b) Releasing Track Authority Limits**

1. When reporting “clear” of Track Authority limits the employee who is reporting “clear” must advise the Train Dispatcher that all main track switches operated have been restored and secured to their normal position. The Train Dispatcher must also be notified in the event no hand-operated main track switches were operated.
2. When a hand-operated switch is used to clear the main track employees must report to the Train Dispatcher that the main track switch has been restored to its normal position and locked. This information must be provided:
  - prior to departing the switch location, and
  - prior to releasing the track authority limits, where applicable

When protection has been provided, the Train Dispatcher may authorize employees to leave the switch in the reverse position.

**3. The Train Dispatcher must:**

- repeat the information and ask the employee if the information is correct
- receive confirmation from the employee reporting “clear” that the information is correct
- not consider the Track Authority limits “clear” until this information is received from the reporting employee

# **CROSSOVERS**

## **203. Crossover Switches**

A crossover switch must not be lined for crossing over while any movement is approaching or passing.

## **204. Crossover Switch Alignment**

Both switches of a crossover must be properly lined before a train, engine, or On-track equipment begins a crossover movement, and the movement must be completed before either switch is restored to normal position.

## **205. Crossover Switches in Correspondence**

The switches of a crossover must be in corresponding position before either crossover switch is used, except when 1 crew is using both tracks connected by the crossover.

## **206. Corresponding Position**

Crossover switches correspond when both are lined for the crossover or both are lined for the straight tracks. Crossover switches must be left in corresponding position after use and in normal position where applicable.



## **SPRING SWITCHES**

### **207. Spring Switches**

Locations and normal positions of spring switches will be designated by Timetable.

### **208. Stopped on Spring Switches**

Trains stopped while trailing through spring switch must not make or allow any facing point movement over switch points until switch has been properly lined by hand.

### **209. Operating Spring Switches by Hand**

The switch lever must not be unlatched for hand operation until switch points have completed movement. When operated by hand, the switch lever must be restored and secured in normal position after movement is completed.

### **210. Restoring Spring Switches**

When a spring switch has been opened to set signals, it may be restored to normal position and locked after leading wheels are on the frog.

### **211. Spring Switch Marker Lights**

A train or engine making a facing-point movement over a spring switch must stop, and a crewmember must line the switch by hand when any of the following conditions exist:

**(a)** A block signal governing movement over the switch indicates:

- Stop
- Restricting

**(b)** A spring switch marker light indicating Stop and Examine Switch Points

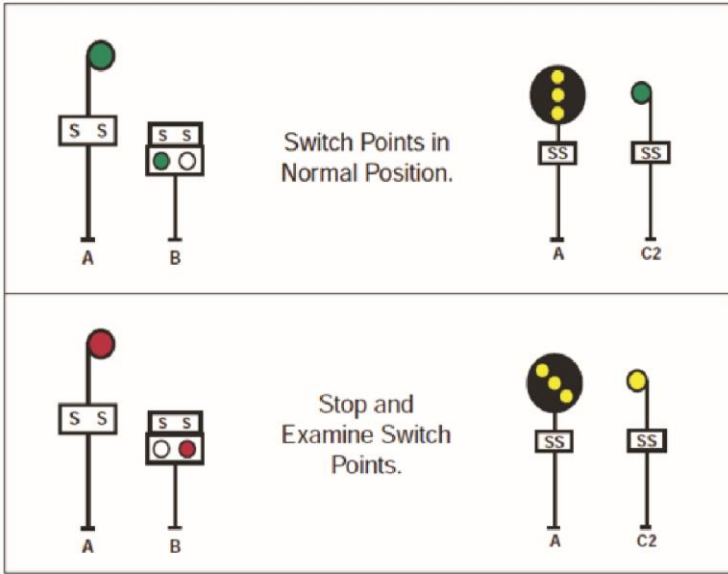

## ***DERAILS***

### **212. Derails: Location & Position**

- (a) Employees must be familiar with the location of derails.
- (b) Normal position of derails is derailing position, and those equipped with locks must be locked. Derails must be kept in derailing position except when changed to permit movement, whether or not any equipment is on the tracks they protect.
- (c) Movements must not pass over derails in derailing position.

### **213. Permanent Blue Signal Derails**

Where authorized by special instructions, permanent “blue signal” derails used for the sole purpose of providing Blue Signal Protection on a non-signaled auxiliary track will be left in non-derailing position when not in use and secured with an effective locking device. These derails will be under the exclusive control of the Mechanical Department and will be placed in derailing position only when providing Blue Signal Protection. Their exact location must be specified in special instructions.

Movements must approach “blue signal” derails at all times expecting to find them in derailing position.

# SHOVE MOVEMENTS

## 215. Shoving Equipment at Any Location

(a) When shoving equipment at any location, a crewmember, or other qualified employee, must take action to prevent damage, protect against conflicting movements, and avoid fouling other tracks.

A crewmember or other qualified employee must be located at, on, or ahead of the leading end, except when:

1. A crewmember or other qualified employee is in a position to visually determine:
  - there is sufficient room in the track to hold the equipment being shoved, and
  - there are no conflicting movements, and
  - intervening road crossings are properly protected
  - intervening switches and derails are properly lined for the intended movement
2. The movement is governed by shove circuits and made in accordance with special instructions.
3. A train may back up one (1) train length on a main track or signaled siding provided the crew knows the train length, and:
  - Does not exceed 15 MPH.
  - Does not exceed the train's authority.
  - Does not enter or foul a public or private road crossing, or pedestrian crossing.
  - Is not made into or within yard limits, Form Y limits, drawbridges or railroad crossings at grade.
  - Does not pass any signal requiring Stop or Restricted speed.
  - Does not pass a Controlled Point unless a member of the crew is in position to continuously observe the signal governing the shoving movement and determine that the train's movement has occupied the circuit evidenced by that signal assuming its most restrictive aspect.

(b) The employee directing the shoving movement must:

1. Not engage in any task unrelated to the oversight of the shoving movement.
2. Inform the Engineer or Remote Control Operator:
  - the means of communication to be used, and
  - how point protection for the shove movement will be provided

(c) Employees are prohibited from protecting shove movements while operating or riding in a moving vehicle.

Employees may protect shove movements while positioned in a stationary vehicle provided:

- A visual determination that the track is clear is made prior to initiation of the shoving movement, and
- The employee can visually observe the movement for the duration of the shoving movement.

*Revised 11/23/15*

## 216. Shoving, Backing, or Pushing Movements

- (a) When radio communication is used in connection with the shoving, backing, or pushing of a train, engine, or other On-Track equipment, the employee directing the movement shall specify the direction of the move (as established in a Job Safety Briefing) and distance seen to be clear.
- (b) The distance of the movement must be specified in 50 foot “car lengths” and the movement must stop in one-half (1/2) the distance last received unless additional instructions are received.

**EXCEPTION:** When within 5 car lengths of the coupling or stop, the person directing the move will call out distances in car lengths, as:

- “five cars”
- “four cars”
- “three cars,” etc.

After acknowledging “five cars,” the Engineer will not be required to further acknowledge countdown if so doing would interfere with safe operation. During this countdown, the Engineer will stop the

move immediately after moving 1 car length unless receiving additional signals from the person directing the move.

- (c) If the instructions are not understood or continuous radio contact is not maintained, the movement will be stopped immediately. The movement may not be resumed until:
1. The misunderstanding has been resolved.
  2. Radio contact has been restored.
  3. Communication has been achieved by hand signals or other procedures.

## **217. Operating a Train from Other than Leading End**

- (a) When the Engineer operates a train from other than the leading end of the movement, a crewmember or other qualified employee must be stationed at, on or ahead of the leading end of the movement to:
- observe conditions ahead
  - maintain hand signal, radio communication, or communicating signal to the Engineer
  - avoid fouling other tracks
- (b) When operating on a main track and the crewmember or qualified employee stationed at, on or ahead of the leading end is equipped with a whistle or horn as well as an emergency brake valve, the movement, unless further restricted, may proceed at a speed not to exceed 30 MPH.
- (c) When operating on a main track and the crewmember or qualified employee is not equipped with a whistle or horn as well as an emergency brake valve, movement must not exceed Restricted Speed.

## **SHOVE LIGHTS**

### **218. Shove Lights – Job Briefing**

Prior to shoving into any track where Shove Lights are being used:

- (a)** A crewmember must conduct a job briefing with the Yardmaster, or other designated employee, to determine if the track is clear, or if a coupling to other equipment will be required. The Yardmaster, or other designated employee, must confirm track occupancy (TYES inventory, yardmaster transfer, etc.) and provide the total length of the equipment to be shoved. If a coupling will be required to equipment not visible to the crewmember stationed at the shove lights, or the shove lights are not illuminated, the shove lights must not be used and the movement must be protected in accordance with **Operating Rule 215**.
- (b)** The crewmember directing the shove movement must have a job briefing with the Engineer / RCO and:
  - Confirm the Engineer / RCO understands the instructions received.
  - Include the means of communication to be used.

### **219. Shove Lights – Shove Movement**

- (a)** The crewmember directing the shove movement must:
  1. Be positioned in clear view of the shove lights during the shove movement.
  2. Not engage in any task unrelated to the oversight of the shove movement.
  3. Communicate with the Engineer/RCO at least every 20 car lengths during the shove. Example: “GM-21 shove light still on, over”.
  4. Immediately notify the Engineer/RCO when the shove light is extinguished.
- (b)** The Engineer/RCO must repeat the information, and must:
  1. Stop the movement if communication is lost.
  2. Operate at a speed that allows stopping the movement in the clear when notified that the shove light is extinguished.

3. Leave the cars in the clear at the shove light end of the track, or as directed by the Yardmaster.
- (c) The above communication requirements do not apply to an RCO when stationed at the shove lights and controlling the movement from the OCU.
  - (d) At locations where a radio announcement provides end-of-track notification, the employee controlling the shove movement must be tuned to the designated radio channel for the duration of the shove movement.

An intermittent “tone” will be broadcast over the designated radio channel during the shove movement. The movement must be stopped if at any time during the shove movement the intermittent “tone” is not heard by the employee directing the shove.

## **220. Yardmaster Responsibility – Shove Lights**

Prior to shoving a track, the Yardmaster or other designated employee, must announce over the designated radio channel the track to be shoved and the job symbol. Example: “NS Pullback GM21 shoving Forwarding Track 10, out”.

## **221. Mechanical Department Responsibility – Shove Lights**

Mechanical Department employees, or their designated representative, working in departure tracks where shove lights are being used, must:

- (a) Conduct a job briefing with the designated Yardmaster prior to working on, or inspecting cars on departure tracks. This job briefing must include:
  - The tracks to be worked or inspected.
  - The planned tracks to be shoved.
- (b) Keep their radios on and tuned to the designated radio channel.
- (c) Notify the Yardmaster when the mechanical work is completed and the employees are in the clear.



# SWITCHING OPERATIONS

## LEAVING EQUIPMENT IN THE CLEAR

### 223. Equipment Left Standing

(a) Equipment must not be left fouling any adjacent track except:

Equipment may be left on:

1. A main track, fouling the siding track, provided the switch is lined for the main track on which the equipment is standing.
2. A siding, fouling the main track, provided the switch is lined for the siding.
3. Yard switching lead, fouling a yard track, provided the switch is lined for the yard switching lead.

When switching industries, crews must be alert for cars left out to foul and must immediately report such occurrences to industry personnel.

(b) The clearance point can be determined by the location of protective devices such as block signals, derails, clearance posts, spring switch signs, or in the case of multi-track territory, the location of the inside switch of a crossover on the adjacent track.

On yard tracks and mechanical shop tracks, if the clearance point is not clearly identifiable by the presence of these protective devices, the equipment must be left:

- Behind the green reflective marker, painted (fluorescent green) crosstie, or other physical identifier in accordance with Special Instructions, or
- 225 feet (4 ½ car lengths) away from the switch point of the track to be occupied, if the painted crosstie, or other physical identifier, is not present or visible.

*Revised 02/19/2015*

## SECURING EQUIPMENT

### 224. Hand Brakes

- (a) When an engine is to be detached, equipment left standing must be properly secured with a sufficient number of effective hand brakes. Air brakes must not be depended upon to hold cars or an unattended engine. After the engine is re-coupled, hand brakes must not be released until the air brake system is properly charged.
- (b) Engines or cars must not be coupled to until it is known that they are secured.
- (c) Cars set off with defective hand brakes must be properly secured and when possible coupled to cars having effective hand brakes.

### 225. Hand Brake Requirements

Car(s) left standing must be secured with hand brakes as follows:

- 1 car — 1 hand brake
- 2 cars — 2 hand brakes \*
- Three or more cars — 2 hand brakes, plus a sufficient number of additional hand brakes to secure the cut of cars

**NOTE:** When applying brakes on cars equipped with multiple hand brakes, all hand brakes on the car must be applied and will be counted as 1 car – 1 handbrake.

**\*EXCEPTION:** When setting a car off on line-of-road with a defective hand brake, only 1 additional car with an effective hand brake applied will be required.

These instructions do not supersede Special Instructions at terminals and yards.

*Revised 11/17/16*

### 226. Testing Hand Brakes

When necessary to control cars by hand brakes, it must be determined that the brakes are working properly.

## 227. Securement of Key Trains

- (a) Except as outlined below, no Key Train or rail cars meeting the definition of a Key Train may be left unattended on a main track or siding outside of a yard or terminal.
1. A properly secured train or rail car may be left unattended at locations specified by timetable or special instructions, or
  2. A properly secured train or rail car may be left unattended:
    - Four (4) hours or less by an on-duty crew during normal railroad activity (e.g. switching operations, swapping locomotives, doubling grade, assisting another train, cutting crossings, etc.).
    - When authorized by the Train Dispatcher during interruption of normal railroad operations (e.g. crew hours of service or no crew available, yard congestion, unable to interchange or deliver to customer due to track capacity, etc.).
    - When authorized by the Train Dispatcher account route impassable (e.g. derailment, mechanical or track/signal defect, crossing accident, inclement weather, or natural/man-made disaster, etc.).
- (b) A Key Train or rail cars meeting the definition of a Key Train left unattended on a main track or siding outside of a yard or terminal must be secured in accordance with all rules and special instructions, and:
1. A test, in accordance with **NS-1, Rule C102**, must be performed to determine that the applied hand brakes are sufficient to secure the equipment.
  2. The reverser must be removed and secured if the controlling locomotive cannot be locked.
- (c) Except when an on-duty crew is leaving properly secured cars unattended during normal railroad activity, the Conductor or Engineer must notify the Train Dispatcher of the following information prior to leaving the equipment unattended:
- Number of hand brakes applied
  - Tonnage and length of train or rail cars
  - Train type, e.g. intermodal, mixed freight, coal train, etc.

- Grade (i.e. ascending or descending), and any relevant weather conditions
- Location of the reverser if removed from the controlling locomotive

The Train Dispatcher must confirm with the Engineer or Conductor that a successful C-102 Test was performed.

## **228. Securement of Equipment**

Anytime emergency responders have been on, under, or between rail equipment, the equipment must not be left unattended until an inspection for proper securement is performed by a qualified employee.

# **GENERAL SWITCHING REQUIREMENTS**

## **229. Switching Operations**

### **(a) Safe and Efficient Switching**

During switching operations, employees must work safely and efficiently, and avoid personal injury, damage to equipment, lading or structures, and fouling other tracks.

### **(b) Stretching**

Prior to shoving, equipment must be stretched to ensure that all cars and / or locomotives are coupled.

## **230. Proper Understanding between Crews When Switching**

When switching at stations or in yards where more than 1 engine may be working on or into the same track, there must be a proper understanding between the crews involved.

## **231. Running or Flying Switches or Dropping Cars**

**(a)** Running or flying switches are prohibited.

**(b)** Gravity dropping cars is permitted when it will not endanger employees, equipment, and lading. Before dropping cars by gravity, crewmembers must conduct a Job Safety Briefing to fully understand the movement. They must:

1. Verify the track has sufficient room to hold the car(s).
2. Check the switch for proper operation.
3. Test hand brakes.
4. Cars may only be dropped by gravity over hand-operated switches.

**(c)** Dropping cars must not be made:

1. With cars displaying hazardous material placards.
2. With cars containing people.
3. To tracks occupied by cars containing people.

## **232. Switching Near Passenger Stations**

- (a)** Crews switching near passenger stations must take precautions to protect all persons.
- (b)** Equipment must not pass between a standing passenger train and the platform that the public and employees are using until safeguards are provided.
- (c)** The Conductor and Engineer of the affected passenger train must not load or unload passengers if a track intervenes between the passenger train and the platform until:
  - 1. The Train Dispatcher has been contacted.
  - 2. Protection against movement on the track(s) between the passenger train and platform is provided.
- (d)** Safeguards for the protection of passengers will be provided by one of the following:
  - 1. Protective blocking applied by the Train Dispatcher on the intervening track.
  - 2. Flag protection.
  - 3. Instructions from the Train Dispatcher/Control Operator to approaching train(s) that equipment must not pass between the platform and a standing train.
  - 4. Verbal arrangements directly between both train crews to either hold the approaching train clear of the platform or permit passage after the platform has been cleared and passengers held in a secure area.

## **233. Passenger Equipment, Camp Cars, Cabooses, and Wheel Cars**

- (a)** When switching or handling passenger equipment or occupied camp cars, air hoses must be coupled and air cut in.
- (b)** Water cars or unoccupied camp cars must not be cut off while in motion.
- (c)** Caboose and wheel cars must be switched and coupled to with care. Except in yards designated by Timetable, when this equipment is cut off in motion, an employee must ride it to control movement.

## 234. Protection of Rail Equipment

When protection to the front of a train is required by rule, crewmember providing protection must go out:

- at least 1 mile where maximum authorized speed is 30 MPH or less
- at least 2 miles where maximum authorized speed is more than 30 MPH

## 235. Wheel Chocks

Except on tracks designated by Timetable Special Instruction, the use of wheel chocks by train and engine employees is prohibited.

## 236. On Curves or in Switches

- (a) When it can be avoided, cars will not be uncoupled or left standing on curves or in switches.
- (b) When necessary to couple to cars on curves or in switches, it must be known that couplers match and coupling speed must be controlled to avoid by-passed couplers or jackknifing. **NOTE:** Special care is required when coupling to cushion-under frame or long cars.

## 237. Mismatched Couplers

When switching or coupling cuts of cars, the coupling must be made to prevent mismatched couplers. Cars will not be cut off to roll free against other cars if one or both cars involved in the coupling are on curved track or in a turnout. Any time a coupling is attempted between equipment on curved track or in a turnout, a member of the crew will be at the point of coupling and will stop the movement short of coupling. The couplers will be aligned if necessary to prevent mismatched couplers before the coupling is completed.

## 238. Cars Being Loaded or Unloaded

Cars being loaded or unloaded must not be coupled to or moved until:

- (a) Plug doors and end doors have been closed and latched.
- (b) Dock boards, transfer plates, tank car couplings, and similar connections have been removed and in the clear.

(c) Wheel chocks have been removed.

(d) Persons in or about cars have been warned, and requested to vacate cars before the cars are switched.

**NOTE:** Where the industry has displayed signs indicating tank cars are connected, other cars must not be placed on the same track obstructing the view of such a sign without first notifying the industry.

### **239. Open Doors on Equipment**

Crews must not pull or switch covered or open-top hoppers with doors open. Top hatches and bottom outlets on covered hoppers are to be closed by the customer prior to pulling car. Loaded cars refused by consignee must not be pulled until all doors have been properly closed and sealed.

Cars equipped with plug doors will not be moved from industrial tracks or out of yards with doors open. Doors must be closed and latched.

End doors must be closed and secured on enclosed multi-level cars before they are moved in a train.



# SIGNAL ASPECTS AND INDICATIONS

## COMMUNICATING SIGNAL INDICATIONS

### 240. Responsibilities; Movement of Trains and Engines on Signal Indication

- (a) Crewmembers must comply with the indication of each signal that affects the movement.
- (b) Crewmembers located in the operating compartment must occupy a window seat when available, and must maintain a vigilant lookout for signals and conditions along the track that affect the movement. Crewmembers located in the operating compartment that cannot avail them of a window seat must maintain a vigilant lookout for signals and conditions along the track, within their view, that affect the movement.
- (c) When crewmembers occupy trailing units their first duty is to observe signals affecting the movement.

### 241. Communicating Block and Interlocking Signals

Employees located in the operating compartment of an engine must communicate to each other in an audible and clear manner the name of each signal affecting movement of their train or engine as soon as the signal is clearly visible. Each signal must be called (1) as soon as it is clearly visible and (2) again, if other than a stop signal, just before the signal is passed. It is the responsibility of the Engineer to have each employee comply with these requirements.

### 242. Conductor Communicating Signals

The Conductor (or a Conductor trainee or trainman in the absence of the Conductor), when occupying the controlling locomotive, will communicate by radio as soon as the signal becomes visible:

- (a) Train identification.
- (b) Signal name.
- (c) Location.
- (d) Track designation when operating in multiple track territory for each signal affecting the movement.

When there is no Conductor, Conductor trainee, or trainman, the Engineer or Engineer trainee will communicate the signal information.

### **243. Crewmembers on Trailing Units Communicating Signals**

Crewmembers occupying trailing units, helper consists, and/or cabooses must:

- (a) Communicate to each other in an audible and clear manner the name of each signal affecting their movement.
- (b) Acknowledge the transmission by repeating to crewmember(s) on the controlling locomotive.

### **244. Communicating Change in Cab Signal Aspect**

In CSS territory, when a change in cab signal aspect occurs, employees located in the operating compartment of the engine must communicate the name of each cab signal affecting the movement in the same manner as a wayside signal when:

- (a) In territory without wayside automatic block signals.
- (b) The indication changes between automatic block signals.

### **245. Signal Indication Information**

- (a) No information may be given by radio to a train or engine crew about the aspect displayed by a fixed signal. Radio may be used by a train crewmember to communicate information about the position or aspect displayed by a fixed signal to other members of the same crew. Radio may be used in an emergency when it is necessary to stop a train or engine or assure its safe movement.
- (b) Except as provided in the Operating Rules, radio communication may not be used to convey instruction that would have the effect of overriding the indication of a fixed signal.

## SIGNALLED MAIN TRACK

### 250. Tracks Designated in the Timetable

- (a) The following rules will be in effect on tracks designated in the Timetable: **Rule 251**, **Rule 261** and **Rule 271**.
- (b) On Tracks Where **Rules 251 or 261** are in effect:
  - 1. Movements entering territory governed by **Rule 251 or Rule 261** will be authorized by proper signal indication or permission from the Train Dispatcher.
  - 2. When permission is received to enter **Rule 261** territory and proceed in one direction, the direction of movement must be specified.
- (c) Where **Rule 271** is in effect, a train or engine must not enter or foul a Main Track without Track Authority.

### 251. Track Signaled in One Direction – Signals Authorize

When track is signaled for movement in one direction only, signal indication will be the authority for trains and engines to operate with the current of traffic and ABS rules apply. Mandatory Directive will authorize movements against the current of traffic and Track Authority rules apply.

### 252. Movements against the Current of Traffic – Rule 251 “Track Signaled in One Direction” Territory

- (a) Train Dispatcher must:
  - 1. Determine the track to be used is clear of opposing movements.
  - 2. Apply blocking devices to protect against opposing movements.
  - 3. Code signals governing opposing movements to Stop.
  - 4. Maintain an Absolute Block.
- (b) Movements operating against the current of traffic must:
  - 1. Be authorized on a Form of Track Authority.
  - 2. Not exceed:
    - \* Freight trains .....49 MPH
    - \* Passenger trains .....59 MPH

3. Receive verbal authority from the Train Dispatcher to operate with the current of traffic according to ABS rules. Before granting permission, the Train Dispatcher must ensure that the track to be used is clear of opposing movements. The Track Authority must be voided.

### **261. Track Signaled in Both Directions – Signals Authorize Movement**

Signal indication will be the authority for trains and engines to operate in either direction on the same track and ABS rules apply.

### **271. Track Signaled in Both Directions – Mandatory Directive Authorizes Movement**

Track Authority rules authorize train and engine movements and ABS rules apply. ABS signals indicate condition of the block.

# TRAIN MOVEMENT IN SIGNALLED TERRITORY

## 272. Lining Route and Clearing Signals

- (a) The proper route must be lined and signals cleared sufficiently in advance of trains, when possible, to avoid unnecessary delay.
- (b) A signal cleared for an approaching train or engine must not be changed until the Engineer or Remote Control Operator has informed the Train Dispatcher the train is stopped. **EXCEPTION:** In an emergency, the signal may be immediately changed to Stop.

## 273. Signals Requiring a Stop

A train or engine approaching a fixed signal requiring a Stop must stop before any part of the equipment passes the signal.

## 274. Stop Obstruction Banners

“STOP OBSTRUCTION” Banners are authorized for monitoring compliance with Restricted Speed on all Norfolk Southern operating divisions. When supervisors are conducting operational checks for compliance with Restricted Speed, a Banner may be erected across the track displaying:



For the purpose of monitoring compliance with Restricted Speed, the Banner will be considered a fixed signal representing a “Stop Signal” and an “Obstruction.” Movements required to observe Restricted Speed must stop short of the “STOP OBSTRUCTION” Banner to be in compliance with the operational test.

The Banner may be erected at any time and at any location where Restricted Speed is required.

## 275. Stopped at a Stop Signal

When a train or engine stops at a Stop signal and no other movement is evident, a crewmember must immediately contact the Control Station.

## 276. Passing a Stop Signal with Proper Authority

### (a) Controlled or ABS

Before passing a Stop signal, a train or engine must have authority to proceed from the Train Dispatcher. Authority to proceed must not be acted upon until:

1. The train or engine has stopped in view of the signal.
2. A crewmember has been fully informed of the situation and knows the move is protected.
3. Instructions received have been repeated to the Train Dispatcher.

**EXCEPTION:** A train or engine may pass a non-controlled STOP signal to couple to equipment standing immediately beyond the signal.

### (b) Automatic Interlocking

When a train or engine is stopped at a home signal at an automatic interlocking and no immediate conflicting movement is evident, the movement will be governed by:

1. Instructions posted at that location, or
2. Instructions in the Timetable.

In **Rule 261** territory, before complying with **Items 1 or 2** above, a crewmember must first communicate with the Train Dispatcher.

### (c) Movable Bridge

A qualified Engineering department employee must inspect the movable bridge and determine that the bridge is locked, the rails are properly lined and seated, and that the bridge is safe for movement before the Train Dispatcher may authorize a train to pass the Stop signal anytime:

1. A bridge “unlock” indication is received. This inspection is required for each train movement while the “unlock” indication is activated.
2. A permissive signal will not display for the first train movement after the bridge has been closed regardless of the bridge lock indication. If the bridge inspection reveals the bridge is locked

and the rails are properly lined and seated, the Train Dispatcher may authorize subsequent train movements to pass the Stop signal without inspection provided the bridge remains closed.

## 277. Authorization to Pass a Stop Signal

- (a) A train or engine must not be authorized to pass a STOP signal unless it is known that no opposing movements are involved.
- (b) Before authorizing a movement to pass a signal displaying Stop, the Train Dispatcher must:
  1. Code the signal(s) governing opposing movements into that section of track to STOP.
  2. Code the signal for the route to be taken by the train or engine to STOP.
  3. Ensure power switch(es) for the route to be taken by the train or engine is indicating in the proper position.

**NOTE:** If the switch(es) is out of correspondence and equipped for dual control operation, each switch that is out of correspondence must be placed on hand operation and lined by hand.
  4. Comply with rules for movement over dual controlled switches if the proper indication for the switch(es) in the desired route cannot be obtained.
- (c) The Train Dispatcher must not authorize a train or engine to pass a STOP signal when the signal can display an indication to proceed except as prescribed in **Rule 292**.
- (d) When a Train Dispatcher authorizes a train or engine to pass a block or controlled point/interlocking signal displaying STOP, authorization will not convey authority to enter limits beyond the signal that are under the jurisdiction of another Train Dispatcher. The train or engine must have authority to occupy the limits beyond the signal or permission must be secured from the governing Train Dispatcher before the limits are entered.
- (e) After authority to pass the Stop signal has been received from the Train Dispatcher, the movement must operate as though a Restricting Signal is displayed.

## 278. Violating a Stop Signal

If any part of a train or engine passes a signal displaying Stop without authority, crewmembers must immediately:

- (a) Stop the train.
- (b) Warn any other movement that could be approaching on any conflicting route by radio. If unable to communicate, provide protection against approaching movement.
- (c) Notify the Train Dispatcher or proper authority.

## 279. Entering Controlled Track between Signals

A train or engine entering a block between signals must proceed at Restricted Speed to the next signal. In cab signal territory, the train may proceed in accordance with cab signal rules and signals.

## 280. Train Delayed in Approach to Automatic Interlocking

A train or engine must proceed prepared to stop approaching an automatic interlocking-railroad crossing at grade when:

- (a) Stopped while approaching or after passing the distant signal.
- (b) Moving less than 25 MPH approaching or after passing the distant signal.

The designated distant signal will be identified by the following sign located in approach to the automatic interlocking:



**EXCEPTION:** This rule will not apply in approach to Automatic Interlocking designated by special instructions.

*Revised 9/28/15*



## 281. Delayed / Stopped in a Block

### (a) Rule 251 and 271 Territory

If a train or engine has entered a block on a proceed indication that does not require Restricted Speed, and is delayed, it must proceed at Restricted Speed. The train or engine may resume the speed authorized by the last signal received when:

1. The next signal is seen to display a proceed indication.
2. The track is seen to be clear to the next signal.

### (b) Rule 261 Territory

If a train or engine has entered a block on a proceed indication that does not require Restricted Speed, and stops, it must proceed prepared to stop at the next signal.

**EXCEPTION:** At points where crews change, unless a leaving signal is provided, Restricted Speed must be observed until leading end of movement reaches the next signal.

### (c) Cab Signal Territory

The requirements above do not apply to trains and engines that have cab signals in service for the direction of movement or that have experienced a cab signal failure in **Rule 368** cab signal territory with- out fixed automatic block signals.

## 282. Movements Stopped Near Controlled Signals

A train or engine stopped with the leading end of the movement within 1 car length of a Controlled Signal must not reverse movement unless the signal can be clearly seen to display an aspect to proceed, or on permission from the Train Dispatcher.

## 283. Next Signal Governing

Trains and engines may operate according to the indication of the next fixed signal governing the movement when the following conditions are met:

- (a) The next governing signal can be plainly seen.
- (b) The train is not required by rule, instruction or the previous signal indication to operate at Restricted Speed.

## **284. Moving from Signaled to Non-Signaled Controlled Track**

When moving from signaled territory to non-signaled territory or track signaled for movement in the opposite direction only:

- (a) Except when entering yard limits or auxiliary track, train or engine must have authority to occupy track beyond the Interlocking or Controlled Point.
- (b) Interlocking and Controlled Point signals only govern movement within Interlocking or Controlled Point limits.

## **285. Beginning and Ending of ABS Territory**

- (a) Where a controlled point or interlocking does not have a distant signal, movements on main track must approach the home signal prepared to stop.
- (b) In addition to its use in non-ABS territory, and “End Automatic Block” sign may be used at the end of ABS territory. In such a case, the last automatic block signal will indicate the condition of the track only to the “End Automatic Block” sign.

## **286. Automatic Block Signal Used in Non-ABS Territory**

An automatic block signal used in non-ABS territory will indicate the condition of the track between that signal and:

- (a) The next signal.
- (b) The “End Automatic Block” sign.

## **287. Unexpected Signal Changes**

- (a) If a signal changes to Restricting or Stop, or if a train or engine encounters a Restricting or Stop signal not indicated by the preceding signal, the movement must:
  1. Stop as soon as possible without endangering the movement.
  2. After stopping, promptly report the occurrence and do not proceed until authorized by the Train Dispatcher.
  3. Proceed at Restricted Speed.
- (b) Crewmembers who are in a position to do so must observe whether signals passed assume their proper indication.

## 288. Absent or Imperfectly Displayed Aspects or Erratic Signals

(a) If any of the following conditions are observed:

1. A signal is functioning erratically.
2. A signal displays no lighted aspect.
3. One or more signal bulbs are not illuminated.
4. A white light is displayed where a colored light should be.
5. A fixed signal is absent from a place where it is usually shown.

The signal must be regarded as the most restrictive indication given by that signal.

### EXCEPTIONS:

1. If the top unit is illuminated on a color light signal and one or more lower units are dark, the dark lower units will, except as noted, be considered to be displaying red. (**NOTE:** On Norfolk and Western if a 3 unit color light signal displays red on the top unit, yellow on the middle unit, and the bottom unit is dark, the signal will be regarded as displaying red over yellow, "Restricting.")
2. If sufficient lights are displayed in a position light, color light, or a color position light signal to determine the indication of the signal, the indication will govern.
3. If more than one indication is possible, and it can be determined that all possible indications are more favorable than Stop, trains and engines may proceed as though a Restricting signal were displayed.

(b) When any of these conditions are encountered a report must be immediately made to the Control Station.

## 289. Improper Signal

Should an Improper Signal indication permitting a train or engine to proceed be observed, crews must:

- (a) Stop as soon as possible without endangering the movement.
- (b) Warn any other movement that could be approaching by radio. If unable to communicate, provide protection against approaching movement.
- (c) After stopping, promptly report the occurrence and do not proceed until authorized by the Train Dispatcher.

# **SIGNAL FAILURE AND REPAIR**

## **290. Shunting – Track**

In signaled territory, a cut of 3 cars or less must not be left standing on rail covered with grease, sand, rust, or other material that may interfere with shunting of track circuits.

In signaled territory whenever cars are pulled or switched from storage tracks and the wheels on these cars show an accumulation of rust, they are not to be cut off and left standing on a signaled track without another car, or cars, attached to them that do not have rusty wheels.

## **291. Testing Signals**

Before testing, permission must be secured from the Train Dispatcher when either:

- switch(es) is to be lined
- signal(s) will be changed to display better than a Stop indication

C&S personnel and the Train Dispatcher must conduct a Job Briefing which includes:

- understanding the effects testing will have on the Signal System
- identifying the location and direction of present or approaching trains and On-Track equipment
- determining the location of other field personnel in the testing area
- determining if Track Authority is in effect adjacent to the location being tested

Before testing can begin, the Train Dispatcher and authorized C&S personnel must meet the following requirements:

- identify the exact signals and switches to be tested
- protect or clear any movements/authorities within the testing limits
- establish protection by blocking each signal authorizing access to the limits that will be affected by testing

After testing is completed, C&S personnel and Train Dispatcher must:

- restore all tested signals to Stop

- ensure all power switch indications correspond with the control machine
- return any field location placed in local control back to control of the Train Dispatcher
- verify through a recall that each controlled point or interlocking tested is restored and in proper correspondence with the Control Station

## 292. Rusty Rail

- (a) When the Signal Department reports that rust or other material may prevent shunting of a track circuit, the Control Station will:
1. Record the report.
  2. Apply blocking devices to switch(es) and signals giving access to that track.
  3. Not permit entry to the effected track by signal indication.
  4. Authorize movement, after stopping, to pass the entrance signal.
- (b) Until the Signal Department authorizes removal, the blocking must be maintained except when operating the switch(es), and must be restored immediately after use.
- (c) After authorizing movement to or from the affected track, the Train Dispatcher must not:
1. Remove blocking.
  2. Operate the switch controls.

Until the entire movement has been reported clear by a crewmember or qualified employee.

## 293. Track Occupancy Lights

The Train Dispatcher must promptly notify the Signal Maintainer or other authorized employee when one of the following conditions exists:

- Track Occupancy Light(s) which is unexplained
- Track Occupancy Light(s) that remains on behind a train
- Track Occupancy Light(s) that remains on after track or signal work
- Signal(s) which is functioning erratically

**NOTE:** When a signal is functioning erratically, trains or engines will be governed by the most restrictive indication that can be displayed by the signal. (A signal is functioning “erratically” when the signal aspect changes from one indication to another indication more than once as viewed from the direction of the approaching train or engine.)

Trains or engines may be permitted to proceed in accordance with the signal indication when a Track Occupancy Light (TOL) clears prior to the arrival of and inspection by the designated employee. If a train or engine arrives at the affected block prior to the arrival of a Signal Maintainer or other responsible employee, the Train Dispatcher may authorize the train or engine to proceed in accordance with current NS Operating Rules. After the arrival of the Signal Maintainer or other authorized employee, the Train Dispatcher must afford the employee a reasonable period of time to:

- make an inspection to determine the cause for the Track Occupancy Light(s)
- take corrective action

Before authorizing a train or engine to enter the affected block.

If the TOL(s) clears before the arrival of the responding employee, the employee still must conduct an inspection to determine the cause of the Track Occupancy Light(s).

The Train Dispatcher must maintain a written record on the train sheet pertaining to each event. The required information to be recorded includes the:

- Date and time
- Location and track designation
- Name of responding employee
- Nature of the problem
- Corrective action taken

## **294. Track Lights Left Behind Trains**

In **Rule 261** territory, any time a train or engine leaves on 2 consecutive track lights or 2 track lights within 25 miles, the Train Dispatcher must immediately:

- Notify the crew to stop and inspect their train.
- Notify the Signal Maintainer and Track Supervisor.

When notified, the crew must:

- Stop and perform a roll-by inspection of one (1) side of the train, not exceeding 10 MPH. The person making the inspection must visually monitor the train during the roll-by inspection for a broken wheel, flat spots, or other defects.
- Notify the Train Dispatcher of the results of the inspection.

## **295. Signal and Switch Malfunction**

- (a) If a signal fails to work properly, its operation must be discontinued, and until repaired, the signal must be secured to display its most restrictive indication.
- (b) When a track, switch, derail, or signal is damaged, undergoing repairs, disconnected, or track is obstructed, STOP signals must be displayed for all routes affected and controls involved must be blocked in such a manner as to prevent their operation.
- (c) Switches and derails must be securely spiked or fastened in the required position if any movement is permitted over them before repairs are completed.
- (d) The signal maintainer must be promptly notified of signal related trouble and given all available information relative to the conditions.

## **296. Suspension of the Signal System**

- (a) If a major failure of the signal system occurs or construction work necessitates, the signal system, or sections of it, may be suspended upon authority of the General Manager.

Upon suspension of the Signal System, the following instructions and procedures for continuing train operations and roadway maintenance and repair will govern.

- (b) Notification of suspension of the Signal System will be by Operations Bulletin.

Effective (time/date) the Signal System on the (Division) (District) between (location) \_\_\_MP and (location) \_\_\_MP is suspended.

Block signals between these locations are out of service and are to be disregarded. NS Operating Rules governing Non-Signaled territory apply.

## 297. Movement Authority during Suspension of the Signal System

- (a) The Train Dispatcher will authorize limits on Track Authority Form within limits of the Signal System suspension.
- (b) Approach Controlled Signal(s) at the following location(s) prepared to stop and do not pass these signals unless authorized by the Train Dispatcher.

EASTWARD/NORTHWARD at (location) MP

WESTWARD/SOUTHWARD at (location) MP

- (c) An Absolute Block must be maintained unless an additional movement has been authorized in “Restrictions” as outlined in **Rules 551, 561 or Track Authority Rules 550, 560, and 562.**

## 298. Operating Instructions during Suspension of the Signal System

- (a) All switches within the limits must be securely spiked or fastened for main track movement.
- (b) Except where Timetable or Train Clearance requires a lower speed, you are authorized to operate at \_\_\_\_\_ MPH.
- (c) Approach all public crossings at grade equipped with automatic warning devices prepared to stop and do not enter crossing until warning device has been activated in sufficient time to warn highway traffic or crossing is protected by flag.
- (d) Defective equipment detectors may be inoperative. Timetable Instructions will govern.
- (e) Approach slide detectors at the following locations at Restricted Speed until way is seen to be clear:

LOCATION \_\_\_\_\_ MP

LOCATION \_\_\_\_\_ MP

- (f) A train operating without a caboose may only be reported clear of the authorized limits in accordance with **Rule 576.**

## 299. Lining Signals in the Field during Code Fail

When a controlled point, Remote Control Station or controlled interlocking is in “code fail” or “CP off line,” the condition of the Signal System is unknown to the Train Dispatcher.



During “code fail” condition, C&S personnel may be requested to clear signals and/or line power operated switches from the field to reduce train delays. Before authorizing C&S personnel to operate the Signal System in a “code fail” condition, the Train Dispatcher and responding C&S personnel must conduct a Job Briefing to determine:

- position of switches and status of signals at the location involved
- location and direction of trains
- location of other field personnel
- Track Authorities in effect for any block within or adjacent to the code fail location

During “code fail” conditions, control of the affected switches and signals from the field is permitted only after the Train Dispatcher and authorized C&S personnel have met the following requirements:

- clear affected area of all Track Authorities and On-Track equipment
- identify the exact switches and/or signals to be lined
- identify (by engine number), direction and location of any affected movement
- determine the desired position of each affected switch

The individual lining switches and clearing signals in the field will be the same individual who communicates with the Train Dispatcher. If the location requires more than 1 field employee to line switches and/or clear signals, the employee communicating with the Control Station will be designated as the “employee in charge.” This employee will:

- create a checklist of the requested switches and signals
- relate, if necessary, this information to field employees at outlying controlled points or interlockings

The controlled point or interlocking must be placed in “manual” operation by the Train Dispatcher, if auto-routing or computer aided dispatching is enabled.

Instructions given by the Train Dispatcher must be repeated by the C&S employee to ensure understanding before routes are changed or signals cleared at the “code fail” location.

After the above conditions are met, the Train Dispatcher may then authorize C&S personnel to line the specified route and clear signals.

Once signals are lined in the field, C&S personnel must verify by use of the local control panel or relay position that the intended route and correct signal is cleared for each train.

Train movement may be authorized to proceed only by the Train Dispatcher after confirmation is received from the C&S employee in charge that the correct route and/or signal is established.

The above requirements must be followed and repeated for each train movement at each location where the route and/or signals are lined in the field.

Where conditions permit, Train Dispatcher must transmit the “control code” that corresponds with the field position of the switch and / or signal in “code fail” lined by C&S personnel.

When C&S personnel in the field have lined the route and cleared the signals, changes must not be made until the movement is complete and trains have cleared the limits. If necessary to change the route and/or signal that has been lined from the field, the Train Dispatcher must first contact the Engineer on the affected train and inform him/her of the intended change. The signal must not be changed until the Engineer has advised the Train Dispatcher that the train is stopped short of the governing home signal at the location of the “code fail.”

# SIGNAL REQUIREMENTS

## 300. General Requirements: Qualifying Features

(a) Signal aspects are identified by:

1. Colors of lights.
2. Positions of lights.
3. Flashing of lights.
4. A combination of color, position, and flashing of lights
5. The shape of the signal background on a position light dwarf or pedestal signal.
6. The shape, color or lettering of signs.

(b) Signal aspects may be qualified by number plate, or letter plate.

(c) The following figure is used with signal aspects to indicate a flashing light:



(d) In the illustrations for **Rules 306** through **319**, the bottom unit of high position light and color light signals (figures A, B, and C(3)) is shown only for aspects that require its use. At signal locations the bottom unit of these signals (if equipped) will be dark for aspects that do not require its use.

## 301. Location of Signals

(a) Signals are generally located to the right of, or directly over, the track they govern. They may be placed to the left of the track they govern where conditions require.

(b) Where 2 signals are located on a bracket post to display indications for 2 tracks, the right-hand signal governs the track to the right and the left-hand signal governs the track to the left.

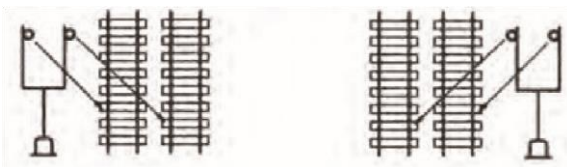

(c) Where a track intervenes between a signal and track governed, a dummy mast, marked by a blue light or reflector, will be placed to the field side of the signal.



### 302. Number Plates

The most restrictive indication of a signal that has a number plate is PROCEED AT RESTRICTED SPEED. The most restrictive indication of a signal that does not have a number plate is STOP.





Number plates are illustrated in these rules only when they are needed to qualify the signal aspect.

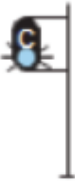
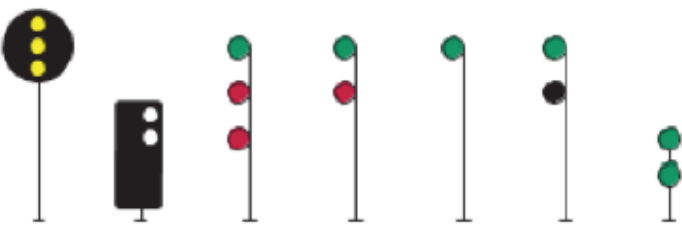
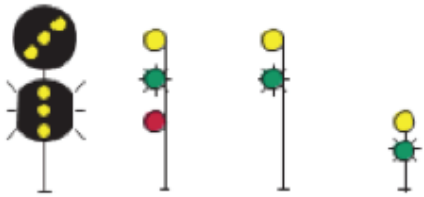
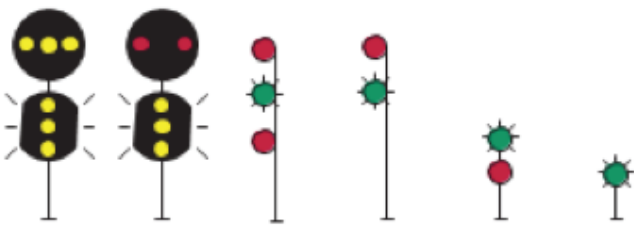

# SIGNAL ASPECTS AND INDICATIONS – CONRAIL SIGNALS

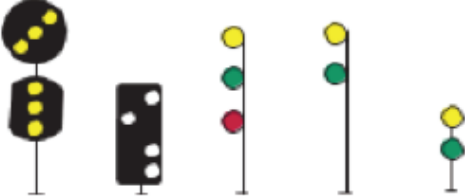
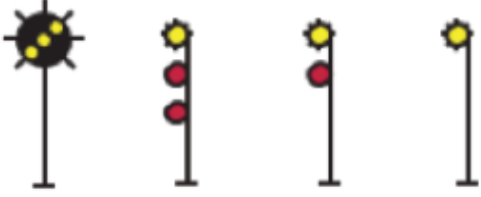
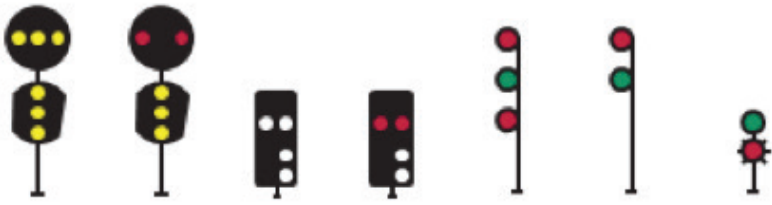

Rule	Aspects
305	<p>LUNAR WHITE</p>  <p>A</p>
306	 <p>A      A1      C      C1      C2      C3      C4</p>
307	 <p>A      C      C1      C4</p>
308	 <p>A      AA      C      C1      C4      C5</p>

Rule	Name	Indication
305	<b>CLEAR TO NEXT INTERLOCKING OR CONTROLLED POINT</b>	<p>Trains with inoperative cab signals or speed control must proceed on fixed signal indication (and cab signal indication, if operable), not exceeding 79 MPH.</p> <p>Trains with inoperative cab signals must approach the next home signal prepared to stop.</p>
306	<b>CLEAR</b>	Proceed at authorized speed.
307	<b>APPROACH LIMITED</b>	Proceed approaching the next signal at Limited Speed.
308	<b>LIMITED CLEAR</b>	<p>Proceed at Limited Speed until entire train clears all interlocking, controlled point or spring switches, then proceed at authorized speed.</p> <p>In CSS territory with fixed automatic block signals, trains not equipped with operative cab signals must approach the next signal at Limited Speed.</p>

Rule	Aspects
309	 <p style="text-align: center;">A      A1      C      C1      C4</p>
310	 <p style="text-align: center;">A      C      C1      C4</p>
311	 <p style="text-align: center;">A      AA      A1      AA1      C      C1      C4</p>
312	 <p style="text-align: center;">C</p>

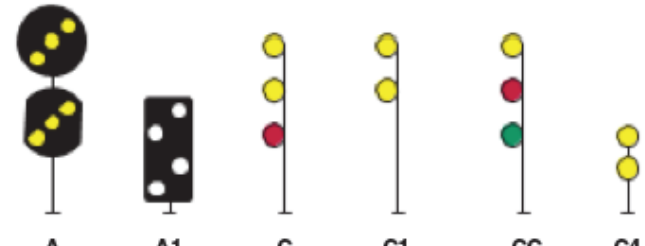
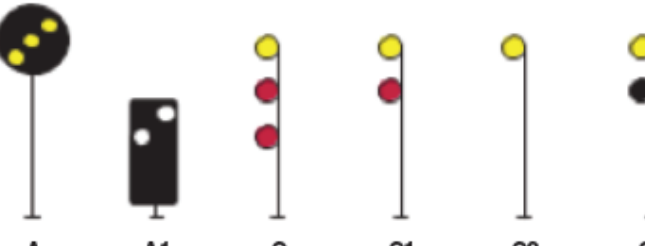

Rule	Name	Indication
309	<b>APPROACH MEDIUM</b>	Proceed approaching the next signal at Medium Speed.
310	<b>ADVANCE APPROACH</b>	Proceed prepared to stop at the second signal. Trains exceeding Limited Speed must begin reduction to Limited Speed as soon as engine passes the Advance Approach signal.
311	<b>MEDIUM CLEAR</b>	Proceed at Medium Speed until entire train clears all interlocking, controlled point or spring switches, then proceed at authorized speed.  In CSS territory with fixed automatic block signals, trains not equipped with operative cab signals must approach the next signal at Medium Speed.
312	<b>MEDIUM APPROACH MEDIUM</b>	Proceed at Medium Speed until entire train clears all interlocking, controlled point or spring switches, then approach the next signal at Medium Speed. Trains exceeding Medium Speed must begin reduction to Medium Speed as soon as the Medium Approach Medium signal is clearly visible.

Rule	Aspects
313	 <p>A      A1      C      C1      CC      C4</p>
314	 <p>A      A1      C      C1      C2      C3</p>
315	 <p>A      AA      A1      AA1      C      C1      C4</p>
316	 <p>A2      A3      C      C4      C5</p>



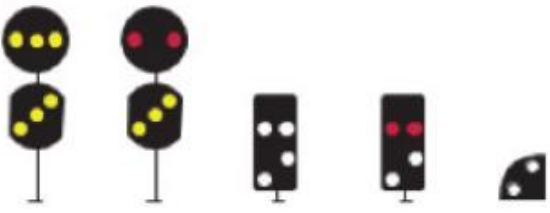
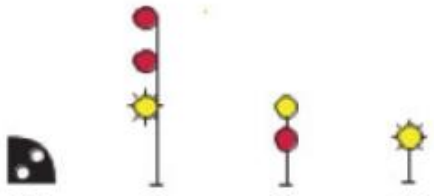
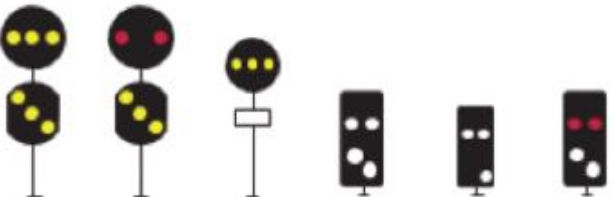
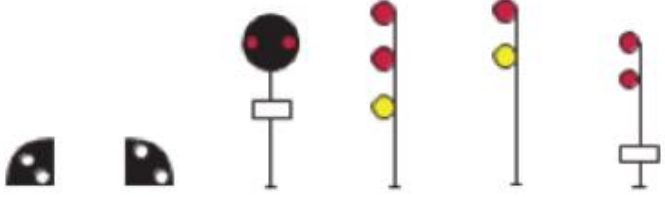
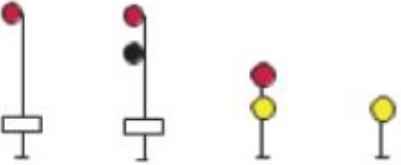

Rule	Name	Indication
313	<b>APPROACH SLOW</b>	Proceed approaching the next signal at Slow Speed. Trains exceeding Medium Speed must at once reduce to that speed.
314	<b>APPROACH</b>	Proceed prepared to stop at the next signal. Trains exceeding Medium Speed must at once reduce to that speed.
315	<b>MEDIUM APPROACH</b>	Proceed prepared to stop at the next signal. Trains exceeding Medium Speed must begin reduction to Medium Speed as soon as the Medium Approach signal is clearly visible.
316	<b>SLOW CLEAR</b>	Proceed at Slow Speed until entire train clears all interlocking, controlled point or spring switches, then proceed at authorized speed.  In CSS territory with fixed signals, trains not equipped with operative cab signals must approach the next signal at Medium Speed once they have left interlocking or controlled point limits.

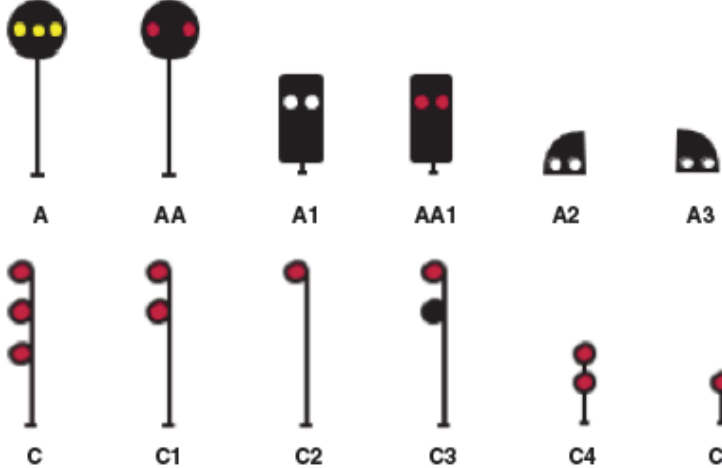
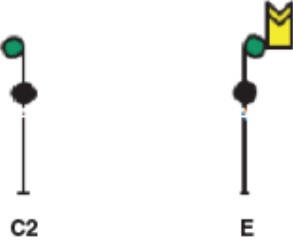
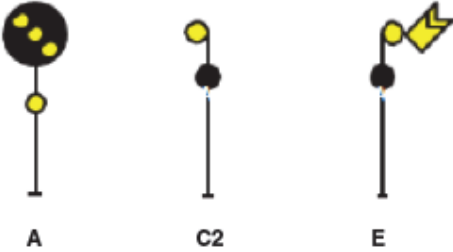
Rule	Aspects
317	 <p style="text-align: center;">A      AA      A1      AA1      A2</p>  <p style="text-align: center;">A3      C      C4      C5</p>
318	 <p style="text-align: center;">A      AA      AB      A1      A1A      AA1</p>  <p style="text-align: center;">A2      A3      BB      C      C1      C1A</p>  <p style="text-align: center;">C2      C3      C4      C5</p>

Rule	Name	Indication
317	SLOW APPROACH	<p>Proceed prepared to stop at next signal. Slow Speed applies until entire train clears all interlocking, controlled point or spring switches, then Medium Speed applies.</p>
318	RESTRICTING	<p>Proceed at Restricted Speed until the entire train has cleared all interlocking, controlled point and spring switches (if signal is an interlocking or controlled point signal) and the leading end has:</p> <ol style="list-style-type: none"> <li>1. Passed a more favorable fixed signal,</li> <li style="text-align: center;">Or</li> <li>2. Entered <b>Rule 171</b> territory.</li> </ol> <p>In CSS territory, trains with operative cab signals must not increase speed until the train has run 1 train length past a location where a more favorable cab signal was received.</p>

Rule	Aspects
319	 <p>A      AA      A1      AA1      A2      A3</p> <p>C      C1      C2      C3      C4      C5</p>
320	 <p>C2      E</p>
321	 <p>A      C2      E</p>

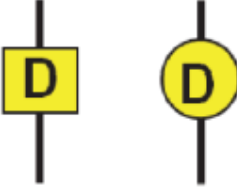

Rule	Name	Indication
319	STOP SIGNAL	Stop.
320	APPROACH CLEAR	<p>Proceed.</p> <p><b>NOTE:</b> Does not convey block or track information.</p>
321	APPROACH RESTRICTING	<p>Proceed prepared to stop at the next signal. Trains exceeding Medium Speed must at once reduce to that speed.</p> <p><b>NOTE:</b> Does not convey block or track information.</p>

Rule	Aspects
322	
323	
324	
325	

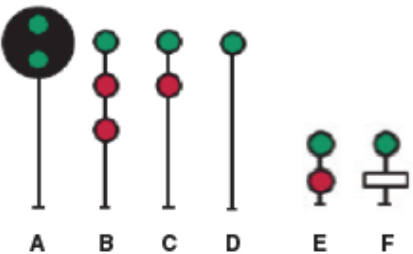

Rule	Name	Indication
322	CLEAR SLIDE DETECTOR SIGNAL	Proceed; slide detector not actuated.
323	SLIDE DETECTOR WARNING SIGNAL	Approach actuated slide detector prepared to stop short of obstruction.
324	DISTANT SIGNAL MARKER	Visual reminder to push-pull trains that <b>Rule 281</b> applies in the block governed by this signal. <b>NOTE:</b> Located on or near the mast of distant signals in territory where push-pull trains operate, cab signals are not in service, and the maximum speed of trains exceeds 30 MPH.
325	DELAYED IN BLOCK SIGN	Visual reminder to push-pull trains that <b>Rule 281</b> applies to station stops made at this station. <b>NOTE:</b> Located at or near the end of passenger stations in blocks between distant signals and home signals in territory where push-pull trains operate, cab signals are not in service, and the maximum speed of trains exceeds 30 MPH.

# SIGNAL ASPECTS AND INDICATIONS – NORFOLK AND WESTERN RAILWAY SIGNALS

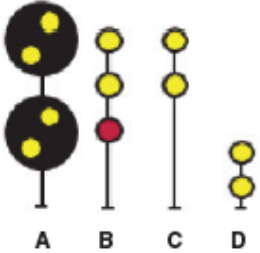
Rule	Aspects
326	 <p style="text-align: center;">A      B      C      D      E      F</p>
327	 <p style="text-align: center;">A      B      C      D</p>
328	 <p style="text-align: center;">A      B      C      D</p>

Rule	Name	Indication
326	<b>CLEAR</b>	Proceed at authorized speed.
327	<b>APPROACH DIVERGING</b>	Proceed preparing to take diverging route beyond next signal at authorized speed.
328	<b>ADVANCE APPROACH</b>	Proceed preparing to stop at second signal.

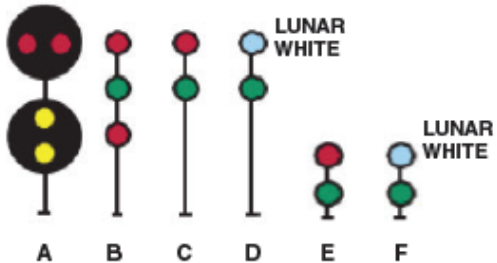
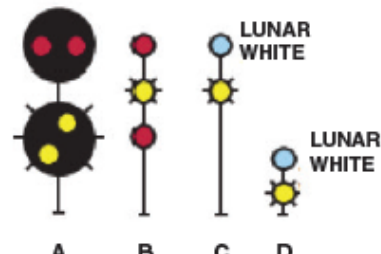
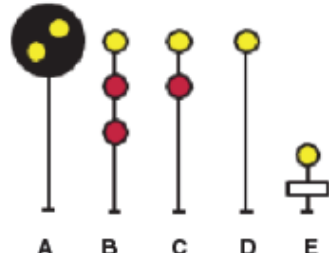
Rule	Aspects
329	 <p>Diagram for Rule 329 showing six aspects (A-F) with various colored circles and lines. Aspect A consists of two large black circles, each containing two smaller circles (red and yellow). Aspect B has a red circle on top, a green circle in the middle, and a red circle on the bottom. Aspect C has a red circle on top and a green circle in the middle. Aspect D has a light blue circle on top and a green circle in the middle. Aspect E has a red circle on top and a green circle in the middle. Aspect F has a light blue circle on top and a green circle in the middle. The text "LUNAR WHITE" is written to the right of aspect D and to the right of aspect F.</p>
330	 <p>Diagram for Rule 330 showing four aspects (A-D) with various colored circles and lines. Aspect A consists of two large black circles, each containing two smaller circles (red and yellow). Aspect B has a red circle on top, a yellow starburst in the middle, and a red circle on the bottom. Aspect C has a light blue circle on top and a yellow starburst in the middle. Aspect D has a light blue circle on top and a yellow starburst in the middle. The text "LUNAR WHITE" is written to the right of aspect C and to the right of aspect D.</p>
331	 <p>Diagram for Rule 331 showing five aspects (A-E) with various colored circles and lines. Aspect A consists of a large black circle containing two smaller yellow circles. Aspect B has a yellow circle on top, a red circle in the middle, and a red circle on the bottom. Aspect C has a yellow circle on top and a red circle in the middle. Aspect D has a yellow circle on top. Aspect E has a yellow circle on top and a white rectangle below it.</p>

Rule	Name	Indication
329	<b>DIVERGING CLEAR</b>	Proceed through diverging route, observing authorized speed through turnout(s) or crossover(s).
330	<b>DIVERGING APPROACH DIVERGING</b>	Proceed through turnout(s) or crossover(s) at authorized speed preparing to take diverging route beyond next signal at authorized speed.
331	<b>APPROACH</b>	Proceed preparing to stop at next signal. Train or engine exceeding Medium Speed must at once reduce to that speed.

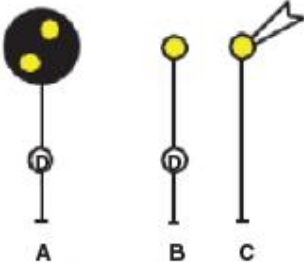
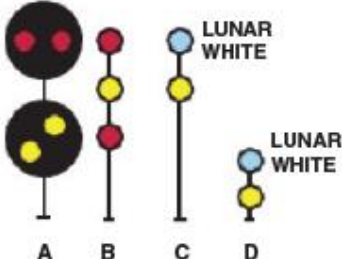
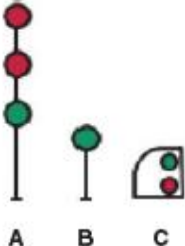

Rule	Aspects
332	 <p style="text-align: center;">A                  B                  C</p>
333	 <p style="text-align: center;">A                  B                  C                  D</p>
334	 <p style="text-align: center;">A                  B                  C</p>

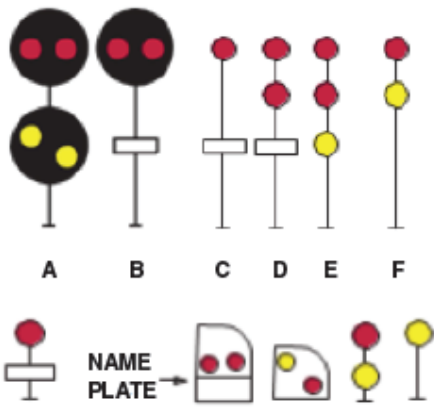
Rule	Name	Indication
332	<b>APPROACH DISTANT</b>	<p>Proceed preparing to stop at next home signal. Train or engine exceeding Medium Speed must at once reduce to that speed.</p> <p><b>NOTE:</b> Signal DOES NOT afford automatic block protection.</p>
333	<b>DIVERGING APPROACH</b>	<p>Proceed through diverging route, observing authorized speed through turnout(s) or crossover(s), preparing to stop at next signal. Train or engine exceeding Medium Speed must at once reduce to that speed.</p>
334	<b>SLOW CLEAR</b>	<p>Proceed; Slow Speed within controlled point/ interlocking limits or through turnout(s) or crossover(s).</p> <p><b>NOTE:</b> Slow Speed applies until leading end of movement reaches opposing home signal when route is lined for straight track movement. Slow Speed applies for entire movement through turnout(s) or crossover(s).</p>

Rule	Aspects
335	 <p style="text-align: center;">A                      B                      C</p>
336	 <p style="text-align: center;">A            B            C            D            E            F</p> <p style="text-align: center;">G            H            I            J            K</p>



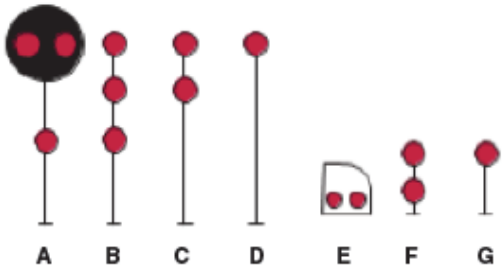





Rule	Name	Indication
335	<b>SLOW APPROACH</b>	<p>Proceed preparing to stop at next signal; Slow Speed within controlled point/interlocking limits or through turnout(s) or crossover(s).</p> <p><b>NOTE:</b> Slow Speed applies until leading end of movement reaches opposing home signal when route is lined for straight track movement. Slow Speed applies for entire movement through turnout(s) or crossover(s).</p>
336	<b>RESTRICTING</b>	<p>Proceed at Restricted Speed.</p> <p>Restricted Speed must be observed until the leading end of the movement reaches the next signal. <b>EXCEPTION:</b> When the signal governs movement to non-sigaled territory or to a track signaled for movement in the opposite direction only, Restricted Speed applies until the leading end of the movement is through any crossovers, turnouts, or controlled point/interlocking limits governed by that signal.</p>

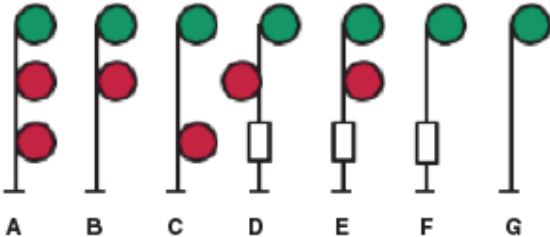
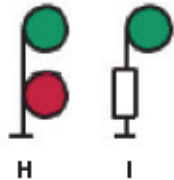
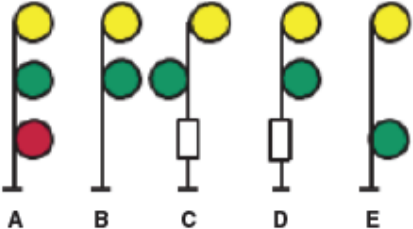

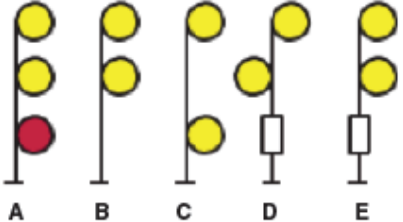

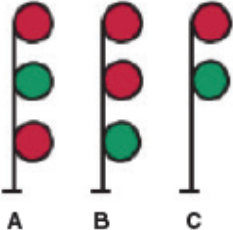
Rule	Aspects
337	 <p style="text-align: center;">A      B      C      D      E      F      G</p>
338	
339	

Rule	Name	Indication
337	STOP	Stop.
338	NON-AUTOMATIC BLOCK, CLEAR	Proceed. <b>NOTE:</b> A train or engine that is delayed after passing this signal must approach next signal prepared to stop. This signal provides information only about the next signal, not conditions of or on the track.
339	NON-AUTOMATIC BLOCK, APPROACH	Approach next signal prepared to stop. Train or engine exceeding Medium Speed must at once reduce to that speed. This signal provides information only about the next signal, not conditions of or on the track.

# SIGNAL ASPECTS AND INDICATIONS – NORFOLK SOUTHERN RAILWAY SIGNALS

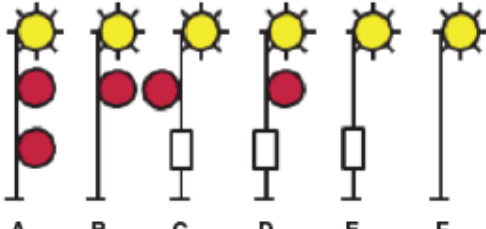
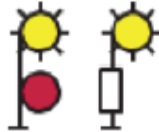
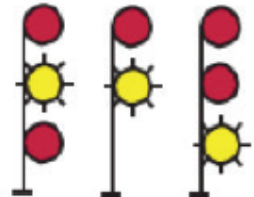

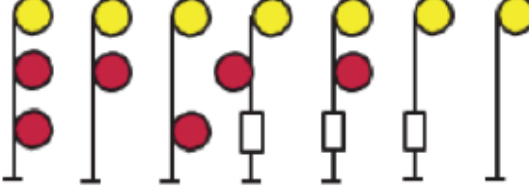
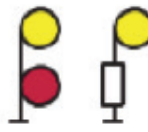

Rule	High Signal	Dwarf Signal
340	 <p style="text-align: center;">A      B      C      D      E      F      G</p>	 <p style="text-align: center;">H      I</p>
341	 <p style="text-align: center;">A      B      C      D      E</p>	 <p style="text-align: center;">F</p>
342	 <p style="text-align: center;">A      B      C      D      E</p>	 <p style="text-align: center;">F</p>
343	 <p style="text-align: center;">A      B      C</p>	 <p style="text-align: center;">D</p>

Rule	Name	Indication
340	CLEAR	Proceed at authorized speed.
341	APPROACH DIVERGING	Proceed preparing to take diverging route beyond next signal at authorized speed.
342	ADVANCE APPROACH	Proceed preparing to stop at second signal.
343	DIVERGING CLEAR	Proceed through diverging route, observing authorized speed through turnout(s) or crossover(s). <b>NOTE:</b> Unless another signal intervenes, movement must be prepared to take diverging route at the next Controlled Signal.

Rule	High Signal	Dwarf Signal
344	 <p>A B C D E F</p>	 <p>G H</p>
345	 <p>A B C</p>	 <p>D</p>
346	 <p>A B C D E F G</p>	 <p>H I</p>
347	 <p>A B</p>	 <p>C</p>

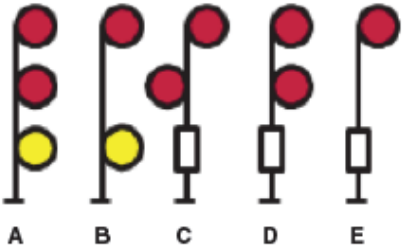

OR 344 & 345 Revised 1/16/17

Rule	Name	Indication
344	<b>APPROACH RESTRICTED</b>	Proceed, approaching next signal at Restricted Speed. Train or engine exceeding Medium Speed must at once reduce to that speed.
345	<b>DIVERGING APPROACH RESTRICTED</b>	Proceed through diverging route, observing authorized speed through turnout(s) or crossover(s), approaching next signal at Restricted Speed. Train or engine exceeding Medium Speed must at once reduce to that speed.
346	<b>APPROACH</b>	Proceed preparing to stop at next signal. Train or engine exceeding Medium Speed must at once reduce to that speed
347	<b>DIVERGING APPROACH</b>	Proceed through diverging route, observing authorized speed through turnout(s) or crossover(s), preparing to stop at next signal. Train or engine exceeding Medium Speed must at once reduce to that speed.

Rule	High Signal	Dwarf Signal
348	 <p>A B C D E</p>	 <p>F G</p>
349	 <p>A B C D</p>	 <p>E F</p>
350	 <p>A</p>	



Rule	Name	Indication
348	<b>RESTRICTING</b>	<p>Proceed at Restricted Speed.</p> <p>Restricted Speed must be observed until the leading end of the movement reaches the next signal. <b>EXCEPTION:</b> When the signal governs movement to non-signalized territory or to a track signalized for movement in the opposite direction only, Restricted Speed applies until the leading end of the movement is through any crossovers, turnouts, or controlled point/interlocking limits governed by that signal.</p>
349	<b>STOP</b>	<p>Stop.</p>
350	<b>NON-AUTOMATIC BLOCK, CLEAR</b>	<p>Proceed.</p> <p><b>NOTE:</b> A train or engine that is delayed after passing this signal must approach next signal prepared to stop. This signal provides information only about the next signal, not conditions of or on the track.</p>

Rule	High Signal	Dwarf Signal
351		
353		

Revised 7/21/16

Rule	Name	Indication
351	<b>NON-AUTOMATIC BLOCK, APPROACH</b>	Approach next signal prepared to stop. Train or engine exceeding Medium Speed must at once reduce to that speed. This signal provides information only about the next signal, not conditions of or on the track.
353	<b>TAKING SIDING INDICATOR</b>	When letter "S" is illuminated, take siding.

Revised 7/21/16





# CAB SIGNAL SYSTEM

Cab Signal System (CSS) rules apply only where designated by Timetable or Operations Bulletin. The CSS is interconnected with the fixed signal system to provide the Engineer with continuous information on the occupancy and/or condition of the track ahead.

This section presents rules governing the use of the CSS, including: movement without cab signals; testing the cab signal apparatus; conformity of cab signal with fixed signals; failure, flip, and nonconformity of the cab signals; and movement with cab signals but without wayside signals.

## 355. Cab Signal Aspects

In accordance with **Rule 358**, “Conformity Between Cab Signals and Fixed Signals,” the following chart illustrates the cab signal aspect that must conform to the applicable fixed signal.

Name	Aspects
CLEAR	
APPROACH MEDIUM	
APPROACH	
RESTRICTING	

The following chart identifies the cab signal(s) that must be displayed to conform to each fixed signal, in accordance with **Rule 358**, “Conformity Between Cab Signals and Fixed Signals.”

Fixed Signal	Conforming Cab Signal(s)
Clear	Clear
Limited Clear	Approach Medium
Medium Clear	Approach Medium
Approach Limited	Approach Medium
Medium Approach Medium	Approach Medium
Approach Medium	Approach Medium
Advance Approach	Approach Medium
Medium Approach	Approach
Approach	Approach
Approach Slow	Approach
Slow Clear	Restricting
Slow Approach	Restricting
Restricting	Restricting
Stop Signal	Restricting

When the movement of a train is governed solely by the cab signal, the indication of the fixed signal with the same name (i.e. Clear, Approach Medium, Approach, or Restricting) will apply. Movements are governed solely by cab signals when:

1. The train is operating in territory where cab signals are used without fixed automatic block signals (**Rule 368**).
2. The cab signal changes between fixed signals (**Rule 359**).
3. The cab signal is more restrictive than the fixed signal when the train enters a block (**Rule 358**).

### 356. Train Not Equipped with Cab Signal Apparatus

(a) The movement of a train not equipped with cab signal apparatus is prohibited, except when authorized by the Timetable.

**EXCEPTION:** Work trains to and from work, and engines moving to and from shops are authorized to operate NOT equipped.

(b) Movements authorized by the Timetable to operate not equipped will:

1. Notify the Train Dispatcher before entering equipped territory.
2. Be governed by fixed signal indication observing Restricted Speed unless the Train Dispatcher authorizes **Rule 362**.

### **357. Testing the Cab Signal Apparatus**

#### **(a) Departure Test**

1. The cab signal apparatus on the leading end of the first engine of each train must be tested and found to be operational within 24 hours before the engine leaves its initial terminal.
2. Engines dispatched from any point destined to cab signal territory must have a departure test and have cab signal equipment cut in before departure.
3. If test equipment is not available at a point where another unit will be required to become a lead unit, this unit must also be tested at the initial terminal.
4. The employee performing the test must post a signed copy of the test results in the cab of the locomotive and must leave a signed copy of the test results at the test location.
5. **Form 12061** will be used to report cab signal and LSL departure tests. The signed white copy is to be placed in the 3-compartment cab car holder on the locomotive. The yellow copy is to be left at the test location at the designated place to receive them.
6. When a copy of the test results cannot be left at the test location, the Train Dispatcher must be notified. The Train Dispatcher must record the engine number, location, name of the person making the test and the results of the test on the record of train movements. The yellow and white copies must be left on the locomotive.
7. If the cab signal apparatus is de-energized after the departure test has been made, it must be tested again before entering equipped territory. Engines dispatched from points in CSS territory to points where test racks are not provided must have the cab signal apparatus energized for the entire trip. Test racks at locations other than terminals will be specified in the Timetable.

## **(b) Engineer's Test of Audible Indicator**

After taking charge of an engine, the Engineer must be assured that the cab signal apparatus is energized and that the audible indicator will sound when the acknowledging device is operated. If the audible indicator fails to sound when the acknowledging device is operated, the Engineer must not enter equipped territory. They must communicate with the Train Dispatcher and advise them of the situation.

## **(c) Operating from Equipped Unit without Departure Test**

If necessary en route to operate from an equipped unit or end that had not been given a departure test, the cab signals must be considered inoperative. **Rule 360**, "Movement with Inoperative Cab Signals," must be observed.

## **(d) Cab Signal Failure on Equipment Used in Turnaround Service**

Under the following conditions, a train that has experienced a cab signal failure may be dispatched from a turnaround point, governed by the rules that apply to an en route failure (**Rules 360, 362 or 368**):

1. The equipment is used in turnaround service between its originating terminal and the turnaround point.
2. The equipment received a satisfactory cab signal test within the previous 24 hours.
3. No mechanical forces are on duty at the turnaround point to repair the equipment.

The crew must advise the Train Dispatcher of the failure before leaving the turnaround point. The equipment must be repaired or replaced at the next forward point that will not cause undue delay to the train.

## **358. Conformity between Cab Signals and Fixed Signals**

### **(a) Cab Signal Does Not Conform to Fixed Signal: More Restrictive Signal Governs**

The cab signal should conform to each fixed signal within 6 seconds after a train enters a block. If the cab signal and fixed signal do not conform, the more restrictive signal indication will

govern movement through the block. The Engineer must notify the Train Dispatcher as soon as possible without delaying the train, giving location and track on which nonconformity occurred.

**(b) Cab Signal Conforms to Fixed Signal: Fixed Signal Governs**

If the cab signal conforms to the fixed signal upon entering the block, the fixed signal will govern.

**359. Cab Signal Changes between Fixed Signals**

If the cab signal changes between fixed signals, the cab signal will govern, subject to the following restrictions:

**(a) Cab Signal Changes to Restricting**

When the cab signal aspect changes to Restricting between fixed signals, the Engineer must take action at once to reduce to Restricted Speed.

**(b) Controlled Point/Interlocking Signal Requires Medium or Limited Speed, Cab Signal Changes to More Favorable Aspect**

If the controlled point/interlocking signal requires Medium or Limited Speed and the cab signal changes to a more favorable aspect, the speed must not be increased until the train has run its length.

**(c) Cab Signal Changes from Restricting to More Favorable**

If the cab signal aspect changes from Restricting to a more favorable aspect, the speed must not be increased until the train has run its length. **NOTE:** Does not apply when a Restricting Signal is received while stopped due to centering the reverser.

**(d) Cab Signal Changes from Clear to Approach Medium**

If the cab signal changes from Clear to Approach Medium between fixed signals, trains must immediately begin reduction to Limited Speed, and must further reduce to Medium Speed, unless the next signal is seen to display a more favorable aspect.

**EXCEPTION:** If the cab signal does not conform to the fixed signal at the entrance to the block, and the fixed signal is more restrictive than the cab signal, the fixed signal will govern movement through the entire block.



### **360. Movement with Inoperative Cab Signals**

The movement of a train equipped with cab signals not in operative condition for the direction of movement is prohibited. The only exception is when failure occurs after the engine leaves its initial terminal.

#### **(a) Engineer's Responsibility**

If the cab signal fails en route, the Engineer must take the following actions:

1. Operate the train according to fixed signal indication and cab signal indication, if operable. Speed must not exceed 40 MPH, unless the Train Dispatcher authorizes **Rule 362**.
2. Pass no signal displaying Restricting, unless authorized by the Train Dispatcher.
3. Notify the Train Dispatcher and Conductor as soon as possible without delay to the train. The reason and location of the failure must be included in this report.
4. Consider the failed apparatus as inoperative until the engine has been repaired, tested and found to be functioning properly.

#### **(b) Train Dispatcher's Responsibility**

Once advised of a cab signal failure, the Train Dispatcher must take the following actions:

1. He must inform the Train Dispatcher of the connecting dispatching district, division, or railroad.
2. He must not grant permission for the train to pass a Stop signal or Restricting signal, until determining that the block to be entered is not occupied. In an emergency, the Train Dispatcher may authorize movement into an occupied block.

### **361. Criteria for Determining Cab Signal Apparatus Failure**

The cab signal apparatus will be considered as having failed if any of the following conditions occur:

- (a)** The audible indicator fails to sound when the cab signal changes to a more restrictive aspect.

- (b) The audible indicator continues to sound even though the cab signal change was acknowledged and the speed of the train was reduced to the speed required by the cab signal indication.
- (c) The cab signal fails to conform at 2 fixed signal locations in succession.
- (d) Damage or fault occurs to any part of the cab signal apparatus.
- (e) When approaching a fixed signal displaying Approach or more favorable aspect in CSS territory without fixed automatic block signals, the cab signal displays Restricting and fails to conform after passing the fixed signal.
- (f) When approaching a fixed signal displaying Slow Clear, Slow Approach, Restricting, or Stop signal, and the cab signal displays an aspect more favorable than Approach.

**EXCEPTION:** This procedure does not apply when the fixed signal being approached is imperfectly displayed.

### **362. Train Dispatcher's Authorizations for Movement**

This rule applies only to:

- (a) Movements authorized by the Train Dispatcher, as provided for in **Rule 356**, "Train Not Equipped with Cab Signal Apparatus" and **Rule 360**, "Movement with Inoperative Cab Signals."
- (b) Movements made in accordance with **Rule 367**, "Cab Signal Portion of Wayside Signaling Equipment Not Operative." Such movements may proceed at Normal Speed, not exceeding 79 MPH. They will be governed by fixed signal indication and cab signal indication if operable, and must not pass a signal displaying Restricting unless authorized by the Train Dispatcher. The Train Dispatcher must not grant permission for such movements to pass a Stop signal or Restricting signal, until he has determined that the block to be entered is not occupied. In an emergency, the Train Dispatcher may authorize movement into an occupied block.

### **363. Train Dispatcher's Responsibility for Recording Movements**

Train Dispatcher must make a written or electronic record on Record of Train Movements the movement of trains operating under any of the following conditions:

- (a) Engines with inoperative cab signals.
- (b) Engines not equipped with cab signals.

The Train Dispatcher must indicate those movements authorized to operate as provided by **Rule 362**, “Train Dispatcher’s Authorizations for Movement,” and **Rule 368**, “Movements in Territory Where Cab Signals are Used without Fixed Automatic Block Signals.”

### **364. Cab Signal Aspect Flips**

- (a) When cab signal aspect “flips,” momentarily changing aspect and then returning to the original aspect, the Engineer must notify the Train Dispatcher as soon as possible without delaying the train. The Engineer must give the following information:

*“Cab signal flipped from [signal name] to [signal name] on No. [track] at [signal bridge or MP No.] or between [designated points if multiple occurrence].”*

- (b) When the “flip” holds for a duration which requires the cab signal to be acknowledged, the Engineer must so state when reporting the occurrence.

### **365. Engineer’s Responsibility to Report on Forms**

In addition to verbally reporting flips, failures, non-conformities, and other unusual occurrences of the CSS apparatus as required by these rules, the Engineer will report them on the locomotive inspection report.

### **366. Circumstances in Which Cab Signal Gives No Indication**

Cab signals will not indicate conditions ahead when the engine is:

- (a) Moving against the current of traffic.
- (b) Pushing cars.
- (c) Running backward but not equipped with cab signal apparatus for backward movement.

### **367. Cab Signal Portion of Wayside Signaling Equipment Not Operative**

If the cab signal portion of the wayside signaling equipment is inoperative, the Train Dispatcher must advise the Engineer verbally indicating the limits of the area affected by the malfunction in the equipment.

The cab signal apparatus must be cut in.

Movement within the limits of the affected area will be governed by **Rule 362**, “Train Dispatcher’s Authorizations for Movement.”

### **368. Movements in Territory Where Cab Signals are Used without Fixed Automatic Block Signals**

The following requirements apply in territory designated by Timetable or Operations Bulletin where cab signals are used without fixed automatic block signals. **Rules 360** and **362** will not apply in territory where this rule is in effect.

#### **(a) Signal Indications**

Interlocking and controlled point signal indications will govern movement within interlocking limits or through controlled points only. Distant signals, where in service, will govern approach to home signals. Between fixed signals, movement will be governed by cab signals.

If the cab signal and fixed signal do not conform when a train passes an interlocking or controlled point signal governing movement into or within **Rule 368** territory, the more restrictive signal indication will govern movement through the interlocking or controlled point. Once the train clears the interlocking or controlled point, movement will be governed solely by the cab signal.

#### **(b) Reverse Movements**

Reverse movement must not be made without verbal permission of the Train Dispatcher. Before granting permission, the Train Dispatcher must determine that the track to be used is clear of opposing movements, and must ensure that blocking devices are applied to protect against opposing movements. Reverse movement must be made at Restricted Speed.

#### **(c) Failure of Cab Signals**

The movement of a train equipped with cab signals not in operative condition for the direction of movement is prohibited. The only exception is when failure occurs after the engine leaves its initial terminal.

If the cab signal fails en route, the Engineer must take the following actions:

1. Notify the Train Dispatcher and Conductor as soon as possible without delay to the train. The reason and location of the failure must be included in this report.
2. Operate at Restricted Speed, unless governed by a “Clear to Next Interlocking” signal, or a Track Authority Form authorizing **Rule 369**.
3. Consider the failed apparatus as inoperative until the engine has been repaired, tested and found to be functioning properly.

The Train Dispatcher must inform the Train Dispatcher of the connecting dispatching district, division, or railroad of the train with inoperative cab signals.

Conductors of trains approaching **Rule 368** territory with inoperative cab signals must remind their Engineer of the requirements of **Item 2** above, when the train is 2 miles from the **Rule 368** territory, or at the last station stop prior to the **Rule 368** territory.

#### **(d) Engineer Not on Leading End**

A train operating with the Engineer on other than the leading end of the movement must operate at Restricted Speed, unless governed by a “Clear to Next Interlocking” signal, or a Track Authority Form authorizing **Rule 369**.

#### **(e) Field Part of CSS Inoperative**

When the field part of the CSS is removed from service by the Signal Department, trains with operative cab signals may be authorized by the Train Dispatcher to operate according to **Rule 305**, “Clear to Next Interlocking.”

The Train Dispatcher must issue trains a Track Authority Form indicating the limits of the CSS outage, and the interlocking(s) or controlled points where **Rule 305** will be displayed. Trains must approach the interlocking(s) or controlled points where **Rule 305** is to be displayed prepared to stop. If **Rule 305** is not displayed, trains must stop and contact the Train Dispatcher for instructions.

If **Rule 305** cannot be displayed, trains must receive a Track Authority Form substituting Track Authority rules for ABS and CSS rules, or a Track Authority Form to operate at Restricted Speed to the next interlocking.

### 369. Authorization for Movement in Rule 368 Territory

Trains operating in Rule 368 territory that have experienced a cab signal failure, or that are operating with the Engineer on other than the leading end of the movement, may be authorized by Track Authority Form to operate according to this rule when “Clear to Next Interlocking” signal cannot be displayed.

The Train Dispatcher must ensure that the track to be used is clear before issuing the Track Authority Form, which must be issued in the following format:

“Operate according to **Rule 369** on No. 2 Track from Tulsa to Parker”

Trains receiving this authorization must not exceed 70 MPH within the designated limits. In addition, trains with inoperative cab signals or with the Engineer on other than the leading end must:

- (a) Approach home signals prepared to stop.
- (b) Determine that all non-interlocked facing point switches are properly lined before passing over them, unless otherwise instructed by the Train Dispatcher.

Determine that warning devices have been operating at least 20 seconds or gates (if equipped) are horizontal before occupying highway crossings equipped with automatic warning devices, unless otherwise instructed by the Train Dispatcher.

# MANDATORY DIRECTIVES

## ***ISSUING AND RECEIVING MANDATORY DIRECTIVES***

### **500. Initiating a Mandatory Directive**

- (a) The Train Dispatcher will state the intention to transmit a mandatory directive.
- (b) When issuing authorities, the Train Dispatcher will use the prescribed preprinted lines on the Authority Forms when applicable
- (c) These records must be made at once and never from memory or memoranda.

### **501. Receiving a Mandatory Directive**

The employee to receive and copy a mandatory directive must state his/her, identification, location, and readiness to receive the mandatory directive before it is transmitted.

### **502. Copying a Mandatory Directive**

- (a) The mandatory directive will be copied in writing on an approved form used specifically for that purpose, or on a Train Clearance.
- (b) A mandatory directive transmitted by radio must be copied and repeated by a crewmember on the controlling locomotive of a train or engine.
- (c) An employee operating the controls of moving equipment may not receive and copy mandatory directives.

### **503. Transmitting a Mandatory Directive**

Both the Train Dispatcher and receiving employee must read aloud all the words, including those preprinted, of each item designated. Multiple-digit numbers must be pronounced, and then repeated digit by digit.

Example:

- 1:14 PM – “One fourteen, 1-1-4 PM”
- 60 – that is six-zero

One-digit numbers and directions must be pronounced and then spelled.

Examples:

- 7 – “Seven, S-E-V-E-N”
- Eastward – “Eastward, E-A-S-T-W-A-R-D”

Station names and other words shall be pronounced and then spelled when necessary for clarity. Decimals will be represented by “dot.”

These requirements must also be observed by employees relaying track authority.

#### **504. Repeating a Mandatory Directive**

After the mandatory directive has been received and copied, it will be immediately repeated in its entirety. The Train Dispatcher must verify the accuracy of the repeated mandatory directive, and will then state the time, and their name.

#### **505. Acknowledging a Mandatory Directive**

- (a) An employee copying a mandatory directive will acknowledge by repeating the time and name of the transmitting Train Dispatcher.
- (b) The Conductor and Engineer must have a written copy of the mandatory directive and all crewmembers must read and understand the mandatory directive before it is acted upon.
- (c) The employee in charge of On-Track Equipment must have a written copy of a mandatory directive and ensure acknowledgment by all employees responsible for its execution before the mandatory directive is acted upon.
- (d) Track Authorities must be double-copied when issued to a Roadway Worker in charge of a work group or to On-Track equipment when two or more employees are present. The Track Authority must be double-copied by writing the contents on a Track Authority form, windshield or white board. (NOTE: For the purpose of double-copying a Track Authority, only the TA number, working limits, and restrictions are required).



When double-copying, both employees must verify that the duplicate copy exactly matches the required contents of the original Track Authority before it is acted upon.

When the copying employees are not in close proximity, the employee with the duplicate copy must listen carefully to the 'repeat' transmission and verify that the duplicate copy exactly matches the contents of the Track Authority. The conversation must be interrupted and the Train Dispatcher notified immediately if any discrepancy is noted during the "repeat" transmission.

Except when written on a windshield or whiteboard, "Double Copy" or "DC" must be written across the top of each double-copied Track Authority.

*Revised 7/27/15*

### **506. Acting upon a Mandatory Directive**

- (a) A mandatory directive that has not been completed may not be acted upon and must be treated as though not sent.
- (b) Information contained in a mandatory directive may not be acted upon by other than those addressed.
- (c) Radio communication must not be used to inform a train of the contents of a mandatory directive not yet transmitted to or received by that train.
- (d) When a train is to be restricted at the point where it is to receive the directive, the train must be stopped and the Train Dispatcher must be notified of the train's exact location before the directive is transmitted.
- (e) If radio communication fails before the copying employee has acknowledged the name of the Train Dispatcher and OK time, the movement addressed must stop and not proceed until communication is restored.

### **507. Voiding a Mandatory Directive**

Mandatory directives that have been voided must be marked "VOID" and retained for the duration of a work assignment

## ***EXCLUSIVE AUTHORITY***

### **510. Exclusive Track Occupancy (ETO)**

A train, engine, roadway worker, or On-Track equipment may be authorized exclusive track occupancy and may operate in both directions. Authority from the Train Dispatcher must be recorded on the prescribed form and include:

- (a)** Identification of the movement
- (b)** Name of person obtaining authority
- (c)** Specified time
- (d)** Specified working limits
- (e)** Track(s) to be used

### **511. Exclusive Authority – Controlled Track**

When authorizing exclusive authority on controlled track the Train Dispatcher must know the affected track is clear of all other movements.

### **512. Precautions Issuing Authorities**

Before issuing an Authority:

- (a)** Train Dispatcher must ensure no overlapping authority is granted within the same limits without proper safeguards.
- (b)** If necessary, other Authorities in effect must be “voided” and reissued to require all movements be made at Restricted Speed within the overlapping limits.

### **513. Protecting Exclusive Authority**

Before authorizing On-Track equipment to enter the limits or after a train or engine has entered the limits, the Control Station must:

- (a)** Code signals governing movement to that track to STOP, and apply protective blocking to the control machine, or
- (b)** Line switches to divert movements from the working limits, and apply protective blocking to the control machine.

## **GIVING AND RECEIVING AUTHORITY**

### **520. Requesting Authority**

Employee requesting authority to occupy the main track must advise the Train Dispatcher of the:

- movements to be made
- tracks to be used, when applicable
- time required

### **521. Authority Form**

Each Authority Form must show the location and name of employee who copied it and any specific instructions issued. (Revised 2/24/17)

### **522. Mandatory Directive Authority Form**

Within Rule 171 or Rule 271 territory, an Authority Form is required for:

- (a) Movement of trains and On-Track equipment.
- (b) Protection of employees occupying or fouling controlled track.

### **523. Designation of Trains**

(a) Trains will be designated by:

- lead engine number
- direction, when applicable

(b) When an engine of another company is used in the lead, it will be designated by the initials or name of the company preceding the engine number.

### **524. Designated Limits**

(a) Limits authorized in the Authority Form must be designated by specifying exact points such as:

- station
- mileposts
- switches

(b) When station names are designated as the:

**First Named Point —**

Authority will extend from either the:

- last siding switch
- station sign if there is no siding

**Second Named Point —**

Authority will extend to either the:

- first siding switch
- station sign if there is no siding

(c) Track must be specified.

**NOTE:** Authority limits designated by other than station names, Controlled Points, or whole mileposts must include both fixed location and milepost. Example: Smith Road, MP 131.27.

## 525. Movement Authority

When authorized:

- (a) Movement may occupy the main track within designated limits, but must not foul a switch at either end of the limits an opposing train may use to clear the main track.
- (b) Movement must be made within the designated limits as follows:
1. “PROCEED” — Movement is authorized ONLY in the direction specified.

Authority will extend to the last siding switch when instructions include “Hold Main Track at Last Named Point”.

2. “WORK BETWEEN” — Movement may be made in either direction between the designated points.

## 526. “Other Specific Instructions”

Train Dispatcher will use “Other Specific Instructions” on Authority Forms only when the situation is not covered by preprinted lines. When used, these instructions must be worded clearly to ensure there can be but one meaning and in such a manner that there can be no hazard to safety.

## **527. Transmitting Contents of an Authority Form**

The Train Dispatcher will transmit the contents of an Authority Form and will then:

- (a) State the total number of boxes marked on the Authority Form.
- (b) Identify the individual box numbers.
- (c) When a train meet is authorized by the Authority, the Train Dispatcher will state “this Authority requires a meet with Locomotive (number), (direction), at (location).”

## **529. Receiving a Track Authority**

The copying employee will record all information and instructions on the Authority Form and will:

- (a) Repeat it to the Train Dispatcher.
- (b) State the total number of boxes marked on the Authority Form.
- (c) Identify the individual box numbers.
- (d) When a train meet is authorized by the Authority Form, the copying employee will state “this Authority requires a meet with Locomotive (number), (direction), at (location).”

## **530. Verifying a Track Authority**

While the copying employee repeats the Authority, the Train Dispatcher will verify contents of the Authority Form and then:

- (a) Restate the total number of boxes marked.
- (b) Identify the individual box numbers.
- (c) Give “OK” and the time.

## **531. Giving “OK” Time**

The “OK” time will be entered on the Authority Form and repeated by the copying employee to the Train Dispatcher. Authority to occupy the track is not in effect until “OK” time is recorded on the form.

## **532. Conductor Not On Controlling Unit**

When the Conductor is not on the controlling unit to receive the copy of the Authority, “OK” must not be given until the copying employee advises the Train Dispatcher that the Authority has been read to and acknowledged by the Conductor.

### **533. Relaying Track Authority Information**

The Train Dispatcher must record Authorities that are relayed through other employees, including the name and location of the relaying employee and the location the train, On-Track equipment, or roadway worker in charge. To ensure that it has been copied correctly, the Train Dispatcher must instruct the relaying employee to require repetition by the receiving employee before “OK” is given.

### **534. “OK”**

An Authority must not be considered in effect by the Train Dispatcher until acknowledgment of the “OK” is received.

### **535. Electronic Transmission**

- (a)** Authority to occupy the track may be transmitted electronically. When transmitted electronically, repetition will not be required. “OK” time will be given at the time transmitted and the space provided for name of copying employee will be left blank.
- (b)** Employees receiving an Authority by electronic transmission must examine each copy for completeness and legibility. They must communicate with the Train Dispatcher to verify the number of each Authority received. (Revised 2/24/17)

## ***AUTHORITIES RESTRICTING MOVEMENT***

### **540. Issuing Authorities Restricting Movement**

When an Authority restricting the movement of a train is issued by telephone at other than initial terminal, "OK" must not be given until the copying employee advises the Train Dispatcher that the Authority Form has been read to and acknowledged by the Engineer.

### **541. Confirmation of Authorities Restricting Movement**

When an Authority restricting a train at or near the point where the restriction applies is to be issued to a crewmember, the Authority must not be transmitted until the Conductor or Engineer assures the Train Dispatcher that they understand their train is to be restricted and they can comply with the restriction.

### **542. Conditional Reminders of Authorities Restricting Movement**

Other crewmembers must remind the Conductor and Engineer of the contents of the Authority Form should conditions require. If necessary, crewmembers will take action to ensure compliance, including stopping the train.

### **543. Conditional Track Authorities – Rule 171 Territory**

The issuance of a Track Authority that includes a Box 6 "Do Not Depart until the Arrival Of" to trains operating in non-signaled territory is prohibited.

*Revised 09/1/2015*

## **JOINT, OVERLAPPING, AND SUBDIVIDED LIMITS**

### **550. Occupying Same Limits**

More than 1 train may be permitted to occupy the same or overlapping limits of an Authority when:

- (a) Trains operating in **Rule 271** (ABS) territory are authorized to move in the same direction.
- (b) Trains are moving on a Proceed Authority through the limits of another train authorized to “WORK BETWEEN” two specific points and all trains are instructed to move at Restricted Speed within the overlapping limits.
- (c) Two or more crews authorized to Work Between the same or overlapping limits provided all movements are made at Restricted Speed within the overlapping limits.

### **551. Protecting Joint or Overlapping Limits of Trains**

The Train Dispatcher may issue Track Authority to authorize multiple movements of trains and engines to occupy the same or overlapping limits by directing each movement to operate at Restricted Speed. This rule will also be observed if a train or engine is authorize to occupy the same or overlapping limits with On-Track equipment.

### **552. Authorizing a Joint Track Authority**

- (a) Joint Track Authority will be required whenever the Control Station cannot block out the involved track section. The Control Station issuing the authority must provide the Operator or person responsible for the On-Track equipment both authority numbers.
- (b) Before a Control Station authorizes working limits which require joint authority with another Control Station, the issuing Control Station must:
  - 1. Contact the joint Control Station for the track section involved.
  - 2. Advise the joint Control Station of the requested working limits and track designation in multiple track territory.
  - 3. Provide the joint Control Station with the issuing Control Station’s authority number.



4. Request protective blocking from the joint Control Station for the specified track segment.
5. Receive and record authority number from the joint control station.
6. Repeat all information to the joint Control Station for correctness.

### **553. Clearing a Joint Track Authority**

To clear a joint track authority, the issuing Control Station must:

- (a) Contact the joint Control Station and advise that the track segment has been reported clear.
- (b) Repeat to the joint Control Station their authority number.
- (c) Notify the joint Control Station that the protective blocking may be removed.
- (d) Repeat all information to the joint Control Station for confirmation.

### **554. Subdividing Limits**

By naming mileposts the Train Dispatcher may subdivide the limits into multiple parts and direct each movement not to pass the specified milepost.

# **AUTHORITIES PROTECTING ROADWAY WORKERS OR ON-TRACK EQUIPMENT**

## **560. Protecting Roadway Workers or On-Track Equipment**

An Authority may be issued, in the same manner as to trains, to permit roadway workers or On-Track equipment to occupy the main track.

## **561. Protecting Joint or Overlapping Limits – Roadway Workers or On-Track Equipment**

Protecting joint or overlapping limits for roadway worker(s) or On Track equipment requires the Train Dispatcher to:

- (a) Protect roadway worker(s) against opposing and following trains and engines.
- (b) Protect multiple movements within joint or overlapping limits by specifying in the Track Authority for each movement:
  1. “Limits are occupied by other On-Track equipment,” or
  2. “**Rule 752**, RWIC (name) Between (location) and (location) on (track).”
- (c) Specify in the Track Authority Form, when permitting On-Track equipment to occupy track behind a train authorized to move in one direction only: “Behind Engine (number), (direction).”

## **562. Requirements for Issuing Overlapping Limits to Roadway Workers or On-Track Equipment**

An Authority must not be issued to protect roadway workers or On-Track equipment within the same or overlapping limits with a train unless:

- (a) All trains authorized to occupy the same or overlapping limits are authorized to move in one direction only and the authority for roadway workers or On-Track equipment to occupy or perform maintenance on main track is granted behind such train.
- (b) Trains authorized to occupy the same or overlapping limits have been notified of the authority granted roadway workers or On-Track equipment and have been instructed to make all movements at Restricted Speed and to stop short of equipment on or fouling

track and employee in charge of On-Track equipment is notified on an Authority Form.

**NOTE:** Roadway Worker Protection rules must be observed if the operator and/or other occupants are engaged in any of the work activities specified in the definition of a “Roadway Worker.”

- (c) Trains, roadway worker(s) and other On-Track equipment authorized to occupy the same or overlapping limits with a roadway worker have been notified of the authority granted the roadway worker in charge of the limits.”

### **563. Roadway Workers & Operators of On-Track Equipment “Do Not Foul Limits Ahead Of”**

When Roadway Worker and Operator of On-Track equipment obtain a Track Authority with Box Eight instructions “*Do Not Foul Limits Ahead Of (engine number) (direction).*,” an accurate determination of each listed train’s location must be made by a member of the work group prior to fouling the track, by using one of the following methods:

- (a) The engine number(s) listed in Box Eight must be physically observed and verified for accuracy and location; or
- (b) Direct communication via radio or in person must be held with a crewmember on board the engine number(s) listed in Box Eight, to confirm the engine number and determine the location; or
- (c) Direct communication must be held with the Train Dispatcher to determine the location of the engine number(s) listed in Box Eight.
- (d) After a positive determination that each train listed in Box Eight has passed the work location, the Roadway Worker in Charge must write their initials and either the time the train(s) passed the location or the time communication was received confirming the train has passed their location on the Track Authority, next to the confirmed engine number(s). Employees receiving authority for joint occupancy of working limits with Box Eight instructions must independently determine the location of each train by using one of the aforementioned methods.

## **CLEARING AUTHORITIES**

### **570. Expiration Time**

Each movement must clear the designated track(s) no later than the specified time, unless the time is extended on authority of the Control Station.

### **571. Expiration of Authority**

If expiration time is shown on an Authority and limits have not been reported clear by that time, the Authority must not be considered void until limits are reported clear.

### **572. Relieved During Tour**

- (a) When a Conductor and / or Engineer is relieved before completion of a trip, all Authority Forms and instructions held must be delivered to the relieving Conductor or Engineer.
- (b) If the Authority Forms and instructions cannot be delivered personally to the relieving crew, Conductor will leave them in an envelope at location designated by the Train Dispatcher and show on the envelope the correct designation of the train, date, location, and Conductor's signature.
- (c) Authority Forms, instructions, and other pertinent information must be compared by the relieving Conductor and Engineer and with the Train Dispatcher before proceeding.

### **573. Reporting Clear**

- (a) An Authority, once in effect, remains in effect until cleared or voided.
- (b) Employees issued an Authority must promptly report to the Train Dispatcher when the train, workers, or equipment is clear of the limits.
- (c) Except as provided by **Rule 572** (Relieved During Tour), the crewmember clearing the Track Authorities must clear all Track Authorities prior to the expiration of his/her HSL time.
- (d) The crewmember reporting clear of a Track Authority to the Control Station must state their name and HSL time and record this information on the "By \_\_\_\_\_ HSL \_\_\_\_\_ M" spaces provided on the Authority.

The crewmember reporting clear will compare the clear time with the HSL time and immediately report any Hours of Service violations to the Train Dispatcher.

#### **574. Clearing Authorized Limits**

- (a) The track authority limits must be reported clear to the Train Dispatcher to void the track authority.
- (b) When reporting clear of authorized limits, the following must be stated to ensure understanding:
  1. Number of Track Authority Form.
  2. Limits being cleared.
  3. Designation of tracks being cleared when operating in multiple track territory.

#### **575. Dispatcher Clearing Authority**

- (a) When the authorized movement reports clear, the Train Dispatcher must:
  1. Verify the Track Authority number and limits.
  2. Acknowledge by stating the time this report is received, such as, "OK, 3:21 PM."
  3. Require this information to be repeated correctly.
  4. Record the time cleared.
- (b) If the employee reporting clear fails to give this information, the Train Dispatcher must ask for and obtain it before the limits are considered to be clear.
- (c) Failure of any movement to report clear by the specified time must be promptly reported to the Chief Dispatcher.

#### **576 . OS'ing (Reporting Passed )**

- (a) The Train Dispatcher will consider the main track "clear" up to and including the point at which the movement is last OS'ed (Reported Passed) by a crewmember, roadway worker, or Operator of On-track equipment, named in the Track Authority. When reporting passed a location, the employee must state the Track Authority number and milepost passed as follows:

“Track Authority No. 8722, NS Engine 5001 (direction) OS’ing by MP 255A”

“Track Authority No. 8723, OT or RW Talent OS’ing (direction) of CP Bell”

The Train Dispatcher must repeat this information to the OS’ing employee, and both employees must enter the OS location and time on the Track Authority form.

- (b) The train must not be OS’ed by a station where there is a siding until the movement has passed the last siding switch.
- (c) A train must not be OS’ed by the limits authorized by an Authority unless:
  - 1. A qualified employee visually confirms the rear-end marker has cleared the limits, or
  - 2. Engine has passed 3\* miles beyond the limits and End-Of-Train Device indicates proper brake pipe pressure on rear.

\* If the controlling locomotive is equipped with a distance counter, and End-Of-Train Device motion detector indicates that rear car is moving, train may be reported clear after the engine has moved a distance equal to the train’s length, plus 500 feet, beyond the limits.

*Revised 11/23/15*

## **577. Voiding a Track Authority**

- (a) When an Authority is in effect and it is necessary to change the limits or instructions, except as provided in **Rule 576**, a new Authority must be issued and include the words “Authority No. \_\_\_\_ is void,” giving the number of the Authority being voided.
- (b) When an Authority of a previous date is voided, the date must be included. (Cancelled 2/24/17)
- (c) The word “VOID” must be written legibly across each copy of the Authority Form when:
  - 1. Limits have been reported clear.
  - 2. Limits or instructions have been changed.

## **IMPROPER HANDLING OF TRACK AUTHORITIES**

### **580. Improper Entries Discovered**

If the issuing or copying employee discovers an improper entry in a Track Authority Form before “OK” or “Time Effective” is given, the issuing employee must direct the copying employee(s) to mark the incomplete form “void” and recopy on a new form.

If an improper entry is discovered in a Track Authority Form after “OK” or “Time Effective” has been given, proper protection must be established and the incorrect Form must be cleared and marked “void”.

*Revised 8/15/16*

### **581. Filling out Forms in Advance**

Track Authority Form, and any similar form, must not be filled out in advance of receiving information from the Train Dispatcher. Once in effect, these forms must not be altered except as provided for by the rules.

# **WEATHER PRECAUTIONS**

## **590. Flash Flood Warning**

- (a) If a Control Station receives notification of a flash flood warning from Accu-Weather, immediate action must be taken to protect employees, train movements, and property where there is a possibility of high water that may damage track or bridges.

When notified, the Train Dispatcher must:

1. Immediately notify all affected train crews of the flash flood warning.
2. Instruct all trains to operate at a speed not to exceed 40 MPH.
3. Immediately notify track and bridge personnel to make an inspection of the affected tracks.
4. Issue any further speed restrictions resulting from track and bridge inspections.
5. Leave speed restrictions in effect until the flash flood warning is canceled and the track and bridge personnel have assessed the need for any continuing speed restrictions.

- (b) Track and Bridge inspectors must:

1. Verify with the Train Dispatcher that the train speed has been restricted as required.
2. After observing local conditions, advise the Train Dispatcher of any additional train speed restrictions.
3. Inspect track and bridge structures with particular attention to bridges and drainage.
4. Inspect the affected tracks for washouts, scour, surface irregularities, and water over the rail, or other weather produced conditions which may make train speed reductions necessary.

- (c) If unusual water level, turbulence, or other conditions prevent a thorough inspection of a bridge or drainage structures, the inspector will notify the Train Dispatcher to limit all trains to operate at Restricted Speed until it is possible to make a proper inspection. If needed, qualified bridge maintenance or engineering employee may be called to assist in the interpretation of inspection results.



(d) When notified, trains must proceed with caution looking out for washouts, water over the rail, or other weather related conditions.

### 591. High Wind Alerts

Anytime a “High Wind” alert is received from AccuWeather, the Control Station must immediately notify all affected train crews and restrict train movements as follows:

- **Wind speed of 66 MPH or greater** - all trains, except loaded bulk commodity unit trains or lite engine movements, must stop. When directed by the Train Dispatcher, affected trains may proceed, not exceeding 20 MPH, to a staging location where trains not affected by the high wind alert may pass.
- **Tornado Warning** - all trains and yard movements must stop. Employees should take immediate shelter on the locomotive or other location until the tornado warning has expired. Where possible, avoid stopping on high bridges or rail-highway grade crossings.

Trains located within the warning location will only be stopped during the time the warning is in effect. Trains that can exit the warning location prior to the effective time should not be stopped.

**EXCEPTION:** Sandusky and Rockville bridges are governed by Division instructions.

# EMPLOYEE RESPONSIBILITIES

## YARDMASTERS

### 600. Authority and Responsibilities; Yardmasters

(a) Yardmasters have charge of:

1. Their respective yards.
2. Making up and distribution of trains.
3. Handling of cars within yards.
4. Yard employees.
5. Train and engine crews while within yard limits.
6. Efficient handling of yard work.
7. Prompt movement of cars.

(b) Where practicable, they must see that:

1. Employees are in condition for the proper discharge of duty.
2. Crews report for duty with the prescribed number of employees at the appointed times.
3. Trains are properly made up and dispatched at the times prescribed.
4. Shipping papers are furnished together with any instructions concerning restricted cars or shipments to Conductors for the movement of cars in their trains.

Yardmasters are responsible for efficient handling of yard work and prompt movement of cars, properly inspected and accompanied by prescribed billing, and for having crews called and trains started at the appointed times.

## **TRAIN SERVICE EMPLOYEES**

### **610. Conductors — Authority and Responsibilities**

- (a) Conductors have charge of trains to which they are assigned.
- (b) They are responsible for:
  1. Safe and proper management of their train.
  2. Protection and care of passengers and property.
  3. Vigilance, conduct and proper performance of duty of other crewmembers.
  4. Observance and enforcement of all rules and instructions.
  5. Proper reporting of all delays.
- (c) Conductors must maintain records and compile reports required by proper authority.
- (d) Before starting, Conductors must secure the prescribed documents and know that air brakes have been properly tested and that trains are ready for movement.

### **612. Seating**

Conductors will occupy a window seat in the operating compartment of the controlling lead unit of moving freight trains unless otherwise instructed by a division officer. The Trainmen must also ride in the lead unit, unless instructed by the Conductor to ride elsewhere.

# **ENGINE SERVICE EMPLOYEES**

## **620. Responsibilities; Engine Service Employees**

- (a) Engine Service Employees are responsible for proper performance and handling of engines, for care of equipment and economical use of fuel and supplies.
- (b) Engine Service Employees must inspect their engines where required, and report any defects or irregular conditions.

## **621. Operating an Engine**

- (a) Only employees certified to do so will operate a locomotive or train.
- (b) A locomotive Engineer trainee may operate a locomotive or train only under direct supervision of a certified Engineer.

## **622. Leaving the Engine Cab**

- (a) Engineer must not leave the engine cab while the train is in motion. When the train is stopped, Engineer may leave the engine cab only when brakes have been properly applied.
- (b) Engineer must not leave the engine while on main track, except to perform duties required by the rules.

## **623. Use Caution; Exercise Care**

- (a) Engineers must use caution and good judgment in starting and stopping trains and controlling slack to prevent damage to equipment.
- (b) In moving and coupling cars, they must exercise care to avoid disturbance to passengers, injury to persons, or damage to equipment or property.

## **624. Use of Sand**

Excessive use of sand is prohibited:

- (a) Within controlled point / interlocking limits.
- (b) Within control circuits of crossing signals.
- (c) When passing over power-operated switches.
- (d) When passing over derails or spring switches.
- (e) On rail connections of drawbridges.

# ***TRAIN DISPATCHERS***

## **630. Responsibilities; Train Dispatchers**

Train Dispatcher will:

- (a) Issue authorities for movement and other instructions as required for the safe and efficient movement of trains and On-Track equipment.
- (b) See that authorities are transmitted, recorded, and repeated according to prescribed forms and rules.
- (c) Ensure that blocking devices applied afford the necessary protection.
- (d) Record the movement of trains.
- (e) Record delays as required.
- (f) Note on the train sheet important incidents occurring during their tours of duty and will make the various other records required.
- (g) Report any violation of the Operating Rules and any irregularity relating to the movement of trains.
- (h) Keep informed of weather and unusual conditions that may affect the movement of trains.
- (i) Ensure that a track is clear of approaching, opposing, or following movements before granting track occupancy or fouling authority.

## **631. Presence on Duty; Relief**

During assigned hours, Train Dispatcher must not leave their offices without permission. Where consecutive shifts are assigned, the Train Dispatcher ending a tour of duty must not leave until relieved.

## **632. Transfer Record**

- (a) When being relieved, Train Dispatcher must prepare a transfer to include:
  1. All outstanding and active movement authorities, track authorities, and messages.
  2. All items included in the Train Clearances currently in effect.
  3. Any other information relative to existing conditions.

- (b) When transferring territory the relieving Train Dispatcher must:
1. Be thoroughly familiar with locations of trains.
  2. Understand the information contained in the transfer.
- (c) The relieving Train Dispatcher, when territories are transferred to their responsibility, must be certain they are thoroughly familiar with locations of trains, understands the information contained in the transfer, and must indicate acceptance of the transfer.

### **633. Blocking Devices**

Whenever the use of blocking devices is required, a record must be maintained. This record must be made at once, never from memory or memoranda. If the record is manually recorded it must be on the prescribed form, and must indicate the time the blocking devices are applied and removed.

Once blocking devices have been applied, they must not be removed until protection is no longer required.

# BLUE SIGNAL PROTECTION

## GENERAL BLUE SIGNAL REQUIREMENTS

### 650. Blue Signal Protection

- (a) Employees must not go under locomotives or cars without blue signal protection as prescribed in this section.
- (b) Employees assigned to inspect, test, repair, or service locomotives or cars must protect themselves against movement of such equipment in compliance with the requirements of blue signal protection.

### 651. Display of Blue Signals

Blue signals displayed in accordance with these rules signify that workmen are on, under, or between rolling equipment. Where required, blue signals must be displayed by each craft or group of workmen and may be removed only by the same craft or group.

When so displayed:

- (a) The equipment may not be coupled to.
- (b) The equipment may not be moved except in a locomotive servicing track area or in a shop repair track area as provided for in **Rule 660(c)**
- (c) Other rolling equipment may not be placed on the same track so as to block or reduce the view of a blue signal except as provided for in **Rule 660(b)** and **Rule 660(c)**.
- (d) If the rolling equipment to be protected includes one or more locomotives, a blue signal must also be attached to the controlling locomotive at a location where it is readily visible to the engineer or operator at the controls of that locomotive. When a blue signal is displayed on the brake valve of the controlling unit, the air brakes must not be applied nor released.
- (e) Rolling equipment may not pass a displayed blue signal.

### 652. Emergency Repair Work

When emergency repair work is to be done on, under, or between a locomotive or one or more cars coupled to a locomotive, and blue signals are not available, the engineer or operator at the controls of that locomotive must be notified and effective measures must be taken to protect the workmen making the repairs.

### **653. Blue Signals Protecting Equipment**

Yard and train crews must not permit equipment to enter a track at a switch where a blue signal is displayed, and must not couple to or move cars, engines, or engines attached to cars, protected by blue signals.

### **654. Blue Signals on a Controlling Unit**

Engine service employees must not move an engine that has a blue signal attached to the controlling unit. When a blue signal is displayed on the brake valve of the controlling unit, the air brakes must not be applied or released.

### **655. Entering an Engine Service Track**

Employees must not move an engine into an engine servicing track until blue signal has been removed from the entrance switch, and the entering engine must stop before coupling.

### **656. Moving Units on Engine Service Track**

Employees must not move an engine from an engine servicing track until blue signals have been removed from the controlling unit and from the departure switch.

### **657. Authority to Move Units on Engine Service Track**

Employees must not move an engine on an engine servicing track without authority of the person in charge of the mechanical force there, and then only after workmen on that track have been notified of the intended movement and blue signal has been removed from the controlling unit of the engine to be repositioned.

### **658. Blue Signal on Main Track**

On main track, before workmen go on, under, or between rolling equipment, a blue signal must be displayed at each end of the rolling equipment.



## **659. Blue Signal on a Remotely Controlled Switch**

Before cars or engines are inspected, tested, repaired or serviced on a track that can be entered at a remotely-controlled switch, the Train Dispatcher must line the switch against movement to track(s) where the work will be done, apply protective blocking to the control machine, and maintain this protection until notified by the person in charge of the workmen that it may safely be removed. The Train Dispatcher must keep written record of:

- (a) Date, time, name and craft of person requesting switch protection.
- (b) Identification of track(s) protected.
- (c) Date, time, name, and craft of person authorizing removal of the protection. These records must be maintained for 15 days.

## **660. Blue Signal on Other Than Main Track**

On other than main track, before workmen go on, under, or between rolling equipment, one or more of the following forms of protection must be provided against movement of equipment:

- (a) Each manually-operated switch providing access to the track must be lined against movement to that track and secured by an effective locking device. A blue signal must be placed at or near each such switch.
- (b) A derail capable of restricting access to the portion of track where work will be performed must be locked in derailing position with an effective locking device and positioned at least 150 feet from the rolling equipment to be protected. A blue signal must be displayed at each such derail.
- (c) In a locomotive servicing area, where fueling and/or servicing is performed or in a car shop repair area, each manually operated switch providing entrance to or departure from the area must be lined against movement to the area and secured with an effective locking device. A blue signal must be displayed at or near each such switch.

A derail positioned at least 50 feet from the end of rolling equipment requiring protection may be used in lieu of a manually operated switch. Such derails must be locked in derailing position and a blue signal must be displayed at each such derail.

Blue signal protection removed for the movement of locomotives into or out of a locomotive servicing area track must be restored immediately after the locomotive(s) clear the switch or derail. Locomotive(s) moved into such an area must be stopped short of coupling to another locomotive.

On a locomotive servicing area track protected by blue signals and under exclusive control of mechanical forces, a locomotive may be repositioned by an authorized employee under the direction of the employee in charge of the workmen, after blue signal has been removed from the controlling unit, and workmen on that track have been warned of the movement. Locomotives with blue signals attached to them must not be coupled to.

On a shop or repair track protected by blue signals and under exclusive control of mechanical forces, rolling equipment may be repositioned with a car mover when operated by an authorized employee under the direction of the employee in charge of the workmen after the workmen on that track have been warned of the movement.

- (d)** Where remotely-controlled switches provide access to the track, the person in charge of the workmen must arrange for protection of those switches by the control operator.

Before cars or engines are inspected, tested, repaired, or serviced on a track that can be entered at a remotely-controlled switch, the operator must line the switch against movement to track(s) where the work will be done, apply blocking to prevent operation of the switch, and maintain this protection until notified by the person in charge of the workmen that it is safe to remove. The operator must maintain for 15 days a written record of each notification which contains the following information:

1. The name and craft of the employee in charge who provided the notification.
2. The number or other designation of the track involved
3. The date and time the operator notified the employee in charge that protection had been provided; and
4. The date and time the operator was informed that the work had been completed, and the name and craft of the employee who provided this information.

- (e) If rolling equipment requiring blue signal protection is on a track equipped with one or more crossovers, both switches of each crossover must be lined against movement through the crossover toward that rolling equipment, and the switch of each crossover that provides access to the rolling equipment must be protected in accordance with the provisions of **Item [a]** or **[d]** unless a derail is being used as provided in **Item [b]**.

### **661. Blue Signals on Industry Tracks**

Cars or engines must not pass beyond the point on a track where the industry has displayed a blue signal, and must not couple to nor move equipment protected by a blue signal. Such a signal may be removed only by industry personnel.

### **662. Protection Required in Connection with End-Of-Train Devices or Markers**

- (a) Blue signal protection is required when an employee, other than a train crewmember, performs the following:
  1. Installs, repairs, or removes an End-Of-Train Device or a portable electric marker.
  2. Examines an End-Of-Train Device or a portable electric marker, on non-main track, to determine that the marker is in operating condition at an initial terminal or crew change point.
  3. Fouls a track to operate the emergency reset function on an End-Of-Train Device.

**EXCEPTION:** Blue signal protection is not required when a brake stick or similar device is used to operate the emergency reset function. The employee must not foul the track or break the plane of the track with any body part.

- (b) Blue signal protection is not required for any employee to examine an End-Of-Train Device or a portable electric marker on a main track to determine that the marker is in operating condition.

**NOTE:** The examiner must personally contact the employee at the locomotive controls for assurance that the train will not move until the marker examination is complete.

### **663. Rolling Equipment under Blue Signal Protection**

Before releasing handbrake(s) on rolling equipment under blue signal protection, effective measures must be taken to protect workmen.

## **UTILITY EMPLOYEES**

### **670. Utility Employees**

The following instructions prescribe protection required for utility employees whose activities require working on, under, or between rolling equipment and subject them to the danger of personal injury posed by any movement of such equipment:

- (a)** A utility employee shall perform service as a member of only 1 train or yard crew at any given time. Service with more than 1 crew may be sequential, but not concurrent. No more than 3 utility employees may be attached to 1 train or yard crew at any given time.
- (b)** A utility employee may be assigned to and serve as member of a train or yard crew without Blue Signal Protection only under the following conditions:
  1. The train or yard crew is assigned a controlling locomotive that is under the actual control of the assigned Engineer or Remote Control Operator.
  2. The Engineer is in the cab of the controlling locomotive, or while the locomotive is stationary, is replaced by another member of the same crew, or the Remote Control Operator has control of the locomotive.
  3. The utility employee established communication with the crew by contacting the ranking crewmember on arriving at the train or yard crew and before commencing any duties with the crew.
  4. Before each utility employee commences duties, the ranking crewmember shall provide notice to each crewmember of the presence and identity of the utility employee. Once all crewmembers have acknowledged this notice, the ranking crew member shall advise the utility employee that he/she is authorized to work as part of the crew. Thereafter,

communications shall be maintained in such a manner that each member of the crew understands the duties to be performed and whether any of those duties will cause any crewmember to go on, under, or between rolling equipment.

- (c)** The utility employee is performing one or more of the following functions:
1. Set or release hand brakes.
  2. Couple or uncouple air hoses and other electrical or mechanical connections.
  3. Prepare rail cars for coupling.
  4. Set wheel blocks or wheel chains.
  5. Conduct air brake tests to include cutting air brake components in or out and position retaining valves.
  6. Inspect, test, install, remove or replace a rear end marking device or End-Of-Train Device.

In all other circumstances a utility employee working on, under, or between rolling equipment must be protected by blue signal.

- (d)** When the utility employee has ceased all work in connection with the train or yard crew and is no longer on, under, or between the equipment; the utility employee shall notify the ranking crewmember. The ranking crewmember shall provide notice to each crewmember that the utility employee is being released from the crew. Once each crewmember has acknowledged the notice, the ranking crewmember shall then notify the utility employee that he/she is released from the train or yard crew.
- (e)** Communications required by Paragraphs B(3) and D shall be conducted between the utility employee and the ranking crewmember either through direct verbal contact or by radio.

# ROADWAY WORKER PROTECTION

## ESTABLISHING ROADWAY WORKER PROTECTION

### 700. Roadway Worker Responsibilities

1. Each roadway worker is responsible for following Roadway Worker Protection safety rules.
2. A roadway worker will not foul a track unless necessary in the performance of duty.
3. Each roadway worker is responsible for ascertaining that On-Track safety is provided before fouling a track. The On-track safety must account for roadway workers engaged in work, including inspection, construction, maintenance or repair, and extending to carrying tools or material that restricts motion, impairs sight or hearing, or prevents an employee from detecting and moving rapidly away from an approaching train or other on-track equipment.
4. The RWP manual must be readily available to roadway workers. Lone workers may access the RWP Manual alternatively by contacting their supervisor and/or electronically, when permitted by rule. *Revised 4/1/17*

### 701. Roadway Worker Job-Briefing

When a roadway worker is assigned duties that require fouling a track, the employee will be provided with a Job Safety Briefing that includes:

- Information on the means by which On-Track safety is to be afforded and instruction on the On-Track safety procedures to be followed and:
- The nature of the work to be performed and the characteristics of the work location.
- Information about any adjacent tracks, and On-Track safety if required or deemed necessary by the Roadway Worker in Charge.
- Identification of any roadway maintenance machines that will foul any adjacent tracks

- Information on the accessibility of the roadway worker in charge and alternative procedures in the event the roadway worker in charge is no longer accessible to the members of the roadway work group. *Revised 4/1/17*

## **702. Roadway Worker Duties**

Every roadway work group whose duties require fouling a track will have 1 roadway worker designated to provide On-Track safety for all members of the group. The designated person must be qualified on the rules prescribing protection for each individual in the group. The responsible person may be designated generally, or specifically for a particular work situation.

## **703. Understanding Before Roadway Workers Foul a Track**

Before any member of a roadway work group fouls a track, the designated person providing On-Track safety for the group will inform each roadway worker of the On-Track safety methods to be used and followed during the performance of the work at that time and location. Each roadway worker must again be so informed at any time the On-Track safety methods change during the work period. Such information will be given to all roadway workers affected before the change is in effect.

## **704. Understanding Before a Lone Worker Fouls a Track**

A lone worker will communicate at the beginning of each duty period with a supervisor, or in the supervisor's absence with another employee who has been designated by a supervisor, to receive a Roadway Worker Protection Job Safety Briefing and to advise his/her planned itinerary and the procedures he/she intends to use for On-Track safety.

A lone worker called out during off-duty hours who anticipates that he/she will have to foul a track will communicate with the employee who calls him/her out to conduct a Roadway Worker Protection Job Safety Briefing and to advise his/her planned itinerary and the rules he/she intends to use for On-Track safety. If this is not possible, the above stated communication must be made with the Train Dispatcher or other employee in charge of train and engine movements where

he/she expects to be working. An interruption in communications does not prevent a lone worker from starting work; however, the Job Safety Briefing must be conducted as soon as possible after the beginning of the work period when communications are restored. *Revised 4/1/17*

## **705. Roadway Worker Visibility**

- (a)** Roadway workers will be provided with highly visible apparel (a white hard hat) that must be worn for the purpose of enhancing detection of their presence by crews of approaching trains and engines or the operator of approaching On Track equipment.
- (b)** The Engineer of an approaching train or engine or the operator of On Track equipment will immediately sound a series of short blasts on the whistle/horn regardless of state laws or ordinances to the contrary.  
The whistle signal must be prolonged or repeated until a member of each roadway work group encountered acknowledges the approaching movement by radio or hand signal.
- (c)** A member of each roadway work group encountered will acknowledge the approaching movement by radio or hand signal.



## **ESTABLISHING WORKING LIMITS**

### **710. On-Track Safety Procedures for Roadway Work Groups**

No roadway worker that is a member of a roadway work group may foul a track unless On-Track safety is provided by one of the following forms of protection:

- (a) Working Limits Generally.
- (b) Exclusive Track Occupancy.
- (c) Train Coordination.
- (d) Inaccessible Track.
- (e) Train Approach Warning provided by Watchmen/Lookout.

### **711. Roadway Workers Fouling a Track**

No roadway worker that is a member of a roadway work group may foul a track without having been informed by the roadway worker in charge of the roadway work group that On-Track safety is provided.

*Revised 4/1/17*

### **712. Work That May Shunt Track Circuits**

Within working limits, when necessary to perform work that may shunt track circuits, permission must first be obtained from the Train Dispatcher.

# **EXCLUSIVE TRACK OCCUPANCY FOR ROADWAY WORKERS**

## **720. Exclusive Track Occupancy**

The authority for exclusive track occupancy given to the roadway worker in charge of the working limits will be transmitted on a written or printed document directly, by relay through a designated employee, in a data transmission, or by verbal communication, to the roadway worker by the Train Dispatcher.

- (a) Where authority for exclusive track occupancy is transmitted verbally, the authority must be written on an authorized Form designed for Track Authority as received by the roadway worker in charge and repeated to the issuing employee for verification.
- (b) The roadway worker in charge of the working limits must maintain possession of the written or printed authority for exclusive track occupancy until the end of the next tour of duty. (Revised 2/24/17)

The Train Dispatcher must make a written or electronic record of all authorities issued to establish exclusive track occupancy.

## **721. Establishing Extent of Exclusive Track Occupancy Limits**

The extent of working limits established through exclusive track occupancy will be indicated by one or more of the following physical features clearly identifiable to a locomotive Engineer or other person operation a train, engine, or other railroad equipment.

- (a) A flagman with instructions and capability to hold all trains, engines, or other railroad equipment clear of the working limits.
- (b) A fixed signal displaying “Stop” or a remotely-controlled switch lined to divert movements away from working limits as prescribed by rule.
- (c) Any station shown in the Timetable that is identified by name with a sign beyond which train movement is prohibited by train movement authority, or Track Authority.
- (d) A milepost beyond which train movement is prohibited by train movement authority, or Track Authority.

- (e) A fixed definable location such as mileposts, switches, road crossings, and bridges, designated by both name and milepost location, including tenths of a mile that trains, engines, or other railroad equipment may not pass unless authorized by the Train Dispatcher.

## **CONDITIONAL STOP SIGNS**

### **725. Conditional Stop Signs – Working Limits**

Working limits become effective at the time specified in Form Y.

### **726. Conditional Stop Signs Job Briefing**

- (a) Prior to the time specified in Form Y, the RWIC must confirm the following with the Train Dispatcher:
  1. The Form Y is correct and has been issued to all affected trains.
  2. The location of the approach boards.
  3. All power-operated switches located within the working limits, and between the Approach and Conditional Stop Signs, have been lined to prevent diverging movements into the working limits and protective blocking has been applied.
- (b) Before work begins or track is fouled by men or equipment, the RWIC must confirm with the Train Dispatcher that all trains are clear of the working limits.

### **727. Conditional Stop Sign Bulletin Item**

Trains approaching the working limits must have a copy of Form Y on their Train Clearance. Form Y must designate the working limits, the name of the RWIC, and the time the working limits are in effect.

### **728. Use of Approach Signs**

- (a) An Approach Sign will indicate the approach to the working limits. An Approach Sign indicates trains and On-Track equipment must be prepared to stop short of the Conditional Stop Sign.
- (b) The Approach Sign must be displayed at least 1 ½ miles in advance of the working limits. **EXCEPTION:** When Form Y limits are near terminals or yards, the Approach Sign may be displayed less than 1½ miles in advance of the working limits. This information must be included in the Form Y.
- (c) The Approach Sign must be displayed not more than 1 hour before the Form Y becomes effective.

## **729. Use of Conditional Stop Sign**

- (a) Conditional Stop Signs may be used to establish working limits on Controlled Track.
- (b) Conditional Stop Signs may be located at mileposts or other fixed definable locations such as switches, road crossings, and bridges when designated by both name and milepost location, including tenths of a mile.
- (c) Conditional Stop Signs must be displayed no later than the time specified in Form Y.

## **730. Placement of Conditional Stop Signs**

- (a) Conditional Stop Signs will be displayed on the right hand side of the affected Controlled Track in the direction of movement.
- (b) Approach Signs will be displayed on the right hand side of the track in approach to the Conditional Stop Signs. In multiple track territory, Approach Signs will be displayed on all affected Controlled Tracks in approach to Conditional Stop Signs located on single track.

## **731. Authorization to Pass a Conditional Stop Sign**

- (a) Before giving permission for a movement to pass a Conditional Stop Sign, the RWIC must determine that:
  - 1. The track through the working limits is not obstructed, and
  - 2. All roadway workers and employees in charge of On-Track equipment have been notified of the approaching movement and are in the clear.
- (b) When notifying a movement that the track is clear, the RWIC will establish radio communication giving permission to pass the Conditional Stop Sign in the following manner:

“ \_\_\_\_\_ (Train symbol or operator of On-Track equipment)  
\_\_\_\_\_ (Engine number, if applicable) the track is clear.  
(Train symbol or operator of On-Track equipment) you have permission to pass the Conditional Stop Sign located at MP \_\_\_\_\_ in \_\_\_\_\_ direction on \_\_\_\_\_ track, not exceeding \_\_\_\_\_ (speed) through the working limits.”
- (c) A crew member located in the cab of the controlling locomotive, or operator of On-Track equipment, must repeat the permission to the RWIC who must verify the repetition for accuracy.

### **732. Entering into Form Y Working Limits**

- (a) Movements must not proceed beyond a Conditional Stop Sign designated in Form Y, or enter main track between the limits of Form Y, until notified by radio or in person by the RWIC named in Form Y that the track is clear.
- (b) If permission to proceed is received before the movement stops, movement may pass the Conditional Stop Sign without stopping.
- (c) Movements that stop within the limits of Form Y must not resume movement without authority from the RWIC named in Form Y.
- (d) Trains and engines must comply with signal indications within the limits of Form Y.

### **733. Reverse Direction or Reverse Movement while within Form Y Working Limits**

- (a) Movements must not reverse direction or make a reverse movement between Conditional Stop Signs stated in Form Y except:
  - 1. Under the specific directions of the RWIC named in Form Y, and,
  - 2. When authorized by the Train Dispatcher
- (b) The RWIC and the Train Dispatcher must be notified when the reverse movement is complete.

### **734. Conditional Stop Sign Located at a Point or Time Not Designated by Form Y**

If a Conditional Stop Sign is found at a location or time not designated by Form Y, the Train Dispatcher must be notified immediately and the movement must not proceed until notified by radio or in person by the RWIC that the track is clear, or the Conditional Stop Sign is removed by proper authority.

### **735. Conditional Stop Sign Not Located at a Point or Time Designated by Form Y**

If a Conditional Stop Sign is not found at the location or time designated by Form Y, the Train Dispatcher must be notified immediately and the movement must not proceed until notified by radio or in person by the RWIC that the track is clear.

## Signs



NAME — APPROACH PREPARED TO STOP SIGN  
INDICATION — APPROACH PREPARED TO STOP  
SHORT OF CONDITIONAL STOP SIGN



NAME — CONDITIONAL STOP SIGN  
INDICATION — STOP UNLESS NOTIFIED BY RADIO  
COMMUNICATION OR IN PERSON BY  
THE EMPLOYEE NAMED IN FORM Y  
THAT TRACK IS CLEAR.

### 736. Form Y

EFFECTIVE FROM \_\_\_\_\_ TO \_\_\_\_\_ ON (DAY), (MONTH)  
(DATE)(YEAR) APPROACH CONDITIONAL STOP SIGN  
NORTHWARD (EASTWARD) AT MP \_\_\_\_\_ ON \_\_\_\_\_  
TRACK AND SOUTHWARD (WESTWARD) AT MP \_\_\_\_\_ ON  
\_\_\_\_\_ TRACK PREPARED TO STOP. DO NOT PASS THIS SIGN  
UNTIL NOTIFIED BY RADIO COMMUNICATION OR IN PERSON  
BY (Employee named in the Form Y) THAT THE TRACK IS CLEAR.  
(Form Y Working Limits are located near \_\_\_\_\_  
(yard/terminal). \_\_\_\_\_ bound approach sign is located at  
\_\_\_\_\_)

### 737. Junctions and/or Switches Located within Working Limits or Between the Approach Sign and Conditional Stop Sign

- (a) The Train Dispatcher must line all power-operated switches located between the Approach and Conditional Stop Sign, and within the limits of Form Y to prevent diverging movements into the working limits and apply protective blocking. Protection must be maintained except when removed to allow a movement:
1. Into the working limits under authority of the RWIC, or
  2. To operate away from the working limits named in Form Y.

- (b)** Hand-operated switches located between Approach and Conditional Stop Signs, and within limits of Form Y, must be lined to prevent access to the working limits, secured with an effective securing device, and tagged.
- (c)** Before displaying a signal or authorizing a movement to enter at a switch or junction located between the Approach and Conditional Stop Signs, and between the limits of Form Y, the Train Dispatcher must:
1. Inform the movement that they will be diverted into Form Y limits at (location).
  2. Instruct the crew member located in the cab of the controlling locomotive or operator of On-Track equipment to contact the RWIC for permission to enter.
  3. Receive confirmation from a crew member located in the cab of the controlling locomotive, or operator of On-Track equipment, that the RWIC has granted permission to enter the limits.



# TRAIN COORDINATION

## 740. Train Coordination

Working limits established on controlled track by a roadway worker in charge using train coordination must be within the segments of track or tracks upon which only 1 train or locomotive holds exclusive authority to move. *Revised 4/1/17*

## 741. Establishing Working Limits by Train Coordination

To establish working limits by train coordination, a roadway worker must communicate with the Engineer, or Conductor if communication cannot be established with the Engineer, in control of the train or locomotive holding the exclusive authority to move, and must determine:

- (a) The train number or controlling locomotive number.
- (b) The train or locomotive is visible to the roadway worker who is establishing the working limits.
- (c) The train or locomotive is stopped.
- (d) That further movements of the train or locomotive will be made only as permitted by the roadway worker in charge of the working limits while the working limits remain in effect, and they will make such movement at restricted speed. (**NOTE:** The train or locomotive does not have to remain within the roadway worker's vision after the initial contact.)
- (e) The working limits are protected from other train and locomotive movements.

## 742. Train Coordination Communication

The roadway worker in charge will communicate with the Engineer or the Conductor if communication cannot be established with the Engineer, in control of the train or locomotive to ensure that the exclusive authority to occupy the track is not terminated until the roadway worker in charge has released the working limits to the Engineer or Conductor. All train crewmembers must be made aware, by the Engineer or Conductor granting the authority, of the working limits granted to the roadway worker in charge.

### 743. Recording Train Coordination Working Limits

When working limits are established by train coordination, the roadway worker in charge must complete the **Joint Occupancy of Work Limits** section of the Engineering Department Track Authority Form TA 1.1(E). The section must include:

- (a) Identification of the train's controlling locomotive number,
- (b) Name of crewmember through which train coordination was established,
- (c) Extent of working limits, and
- (d) Time working limits are in effect.

**NOTE:** Train Coordination may be established by a single employee or an employee in charge of a work group or gang.

TA 1.1(E) Forms with the **Joint Occupancy of Work Limits** section completed must be retained until the end of the next tour of duty.  
(Revised 2/24/17)

# **INACCESSIBLE TRACK**

## **745. Inaccessible Track**

Working limits on Non-Controlled Track will be established by rendering the track within working limits inaccessible to trains, engines, or other railroad equipment. No train, engine, or other railroad equipment, except those moving under the direction of the roadway worker in charge, may be located within working limits on non-controlled track.

## **746. Working Limits of Inaccessible Track**

The extent of working limits established as inaccessible track must be defined by one or more of the following physical features:

- (a)** A flagman with instructions and capability to hold all trains, engines, or other railroad equipment clear of the working limits.
- (b)** A hand-operated switch or derail aligned to prevent access to the working limits and secured with an effective securing device.
- (c)** A remotely-controlled switch aligned to prevent access to the working limits, and the Train Dispatcher:
  - 1. Has secured the switch by applying protective blocking to the control machine.
  - 2. Has notified the roadway worker who requested the working limits that the protection has been provided.
  - 3. Is not permitted to remove the protective blocking until receiving permission to do so from the roadway worker who requested the working limits.
  - 4. The operator of the remotely-controlled switch must maintain a record for 15 days that includes:
    - a. Date, time and name of person requesting switch protection.
    - b. Identification of track(s) protected.
    - c. Date, time, and name of person authorizing removal of the protection.
- (d)** An obstruction in or on the track that prevents passage of trains, engines, or other railroad equipment into the working limits.

- (e) Working limits on controlled track that connects directly with the inaccessible track, established by the roadway worker in charge of the working limits on the inaccessible track.
- (f) A locomotive with or without cars placed to prevent access to the working limits at one or more points of entry to the working limits, provided the following conditions are met:
1. The roadway worker in charge who is responsible for establishing working limits communicates with a member of the crew assigned to the locomotive and determines that the locomotive is stopped and visible to the roadway worker in charge that is establishing the working limits.
  2. Further movements of the locomotive may be made only as permitted by the roadway worker in charge controlling the working limits.
  3. The crew of the locomotive must not leave the locomotive unattended or go off duty unless communication occurs with the roadway worker in charge and an alternate means of on-track safety protection has been established by the roadway worker in charge.
  4. Cars coupled to the locomotive on the same end and on the same track as the roadway workers shall be connected to the train line air brake system and such system must be charged with compressed air to initiate an emergency brake application in case of unintended uncoupling. Cars coupled to the locomotive on the same track on the opposite end of the roadway workers must have sufficient braking capability to control their movement. *Revised 4/1/17*

## 747. Switch or Derail Tags

When a switch or derail has been tagged out of service and secured with an effective securing device for the protection of roadway workers, the tag and/or securing device must not be removed except by direction of the person in charge of the workers being protected.

## **WORKING LIMITS**

### **751. Control of Working Limits**

Not more than 1 roadway worker will have control over working limits for the purpose of establishing On-Track safety.

### **752. Movements of Trains and Engines within Working Limits**

Trains, engines, and other railroad equipment will not jointly occupy the same or overlapping working limits with a roadway worker except as prescribed by rule and when authorized by the roadway worker having control of the limits.

Movement of trains, engines, and other railroad equipment within the working limits will be made only under the direction of the roadway worker having control of the limits. Such movements will be at Restricted Speed unless a higher speed is specifically authorized by the roadway worker having control of the limits.

### **753. Notification before Releasing Working Limits**

All affected roadway workers must be notified before working limits are released for the operation of trains, engines, or other railroad equipment. Working limits must not be released until all affected roadway workers have either left the track or have been afforded On-Track safety through train approach warning (watchman/lookout).

### **754. Working Limits on Controlled Track**

Working limits on Controlled Track must be protected as prescribed by Exclusive Track Occupancy.

### **755. Working Limits on Non-Controlled Track**

Working limits on Non-Controlled Track must be protected as prescribed by Inaccessible Track.

## **TRAIN APPROACH WARNING PROVIDED BY WATCHMEN / LOOKOUTS**

### **756. Train Approach Warning Provided by Watchmen / Lookouts**

Roadway workers in a roadway work group who foul any track outside of working limits will be given warning of approaching trains, engines or other railroad equipment by one or more watchmen/lookouts in accordance with the following provisions. (**NOTE:** Train Approach Warning will not be used for protection of On-Track equipment or for any track maintenance or construction that would interfere with the safe passage of trains and engines.)

### **757. Train Approach Warning Notification and Attention**

- (a)** Train approach warning must be given in sufficient time to enable each roadway worker to move to and occupy a pre-determined place of safety not less than 15 seconds before a movement operating at maximum authorized speed on that track can pass the location of the roadway worker. The place of safety to be occupied upon the approach of a train, engine, or other railroad equipment may not be on a track, unless working limits are established on that track.
- (b)** Watchmen/lookouts assigned to provide train approach warning must devote full attention to detecting the approach of trains, engines, or other railroad equipment and communicating a warning thereof, and must not be assigned or perform any other duties while functioning as watchmen/lookouts. *Revised 4/1/17*

### **758. Watchman / Lookout Equipment**

Watchmen/lookouts must be properly equipped to provide Train Approach Warning. The means used by a watchman/lookout to communicate a Train Approach Warning must be distinctive and clearly signify to all recipients of the warning that a train, engine, or other railroad equipment is approaching.

The method of communicating a Train Approach Warning must be provided by one of the following means:

- (a)** Sounding a whistle, air horn, or other audible warning device.
- (b)** Communicating verbally.

(c) Touching the roadway worker(s).

The method used to provide Train Approach Warning must be covered in the Job Safety Briefing.

### **759. Employee Positioning and Communication when Using Train Approach Warning**

- (a) Every roadway worker who depends upon train approach warning for On-Track safety must maintain a position that will enable him/her to receive a train approach warning communicated by a watchman/lookout at any time while On-Track safety is provided by train approach warning.
- (b) Watchmen/lookouts will communicate train approach warnings by a means that does not require a warned employee to be looking in any particular direction at the time of the warning, and which can be detected by the warned employee regardless of noise or distraction of work.
- (c) The use of advance watchmen/lookouts to provide train approach warning is prohibited. *Revised 3/3/17*

# ADJACENT CONTROLLED TRACK

## 760. Adjacent Controlled Track

Unless specifically excepted by **Rule 763**, On-Track safety is required for each adjacent controlled track when a roadway work group with at least one of the roadway workers on the ground is engaged in a common task with On-Track, self-propelled equipment or coupled equipment on an occupied track.

On-Track safety must be established through Working Limits or Train Approach Warning provided by Watchmen/Lookouts.

## 761. Movement on Adjacent Controlled Tracks

- (a) When a warning of an approaching train is received from a watchman/lookout, or a notification that the RWIC intends to authorize a movement on the adjacent controlled track, each roadway worker on the occupied track must:
- Cease all on-ground work and equipment movement on or between the rails and on both sides of the occupied track, and
  - Occupy a predetermined place of safety.
- (b) Where movement on the adjacent controlled track is authorized at 25 MPH or less, or 40 MPH or less for passenger trains:
1. On-Track Equipment may be operated on the occupied track, not exceeding 5 MPH while the train is passing, and on-ground work performed exclusively between the rails of the occupied track may continue provided no on-ground work is performed within 25 feet in front or 25 feet behind any On-Track, self-propelled equipment or coupled equipment.
  2. On-ground inspection and light maintenance work performed exclusively between the rails of the occupied track may continue within 25 feet ahead or behind any “stationary” On-Track, self-propelled equipment or coupled equipment provided the operator of the On-Track equipment confirms that the equipment:
    - a. Is “stationary”, and
    - b. Will not resume On-Track movement until permission is received from the affected on-ground workers.



- (c) At locations where an occupied track has two adjacent controlled tracks (one on each side), and one of the adjacent controlled tracks has movements authorized at speeds greater than 25 MPH, or greater than 40 MPH for passenger trains, the requirements of paragraph (a) above apply for both adjacent controlled tracks.

## **762. Resuming Work**

- (a) Roadway workers may resume normal equipment operation on the occupied track, and on-ground work between the rails and on both sides of the occupied track, only after the trailing-end of the movement on the adjacent controlled track has passed and remains ahead of the roadway worker.
- (b) If the movement on the adjacent controlled track stops before its trailing-end has passed all of the roadway workers in the roadway work group, the work between the rails and on both sides of the occupied track ahead of the trailing-end of the movement may resume:
- If train approach warning is established on the adjacent controlled track, or
  - If the RWIC has communicated with a member of the train crew, or On-Track equipment operator, and confirmed that further movements will only be made as permitted by the RWIC.

## **763. Exceptions to On-track Safety for Adjacent Controlled Tracks**

On-Track safety is not required on an adjacent controlled track under the following conditions:

- (a) As provided below, on the side of the occupied track with:
- No adjacent track
  - Adjacent tracks, the closest of which has working limits and no movements are permitted by the RWIC
  - Adjacent tracks with an inter-track barrier between the occupied track and the closest adjacent track
    1. A roadway work group with all on-ground roadway workers exclusively positioned on the side of the occupied track outlined above.

2. One or more roadway workers performing maintenance or repairs to roadway maintenance machines or coupled equipment on the occupied track when alongside, on or under a roadway maintenance machine or coupled equipment provided the work is being performed on the side of the occupied track outlined above, provided:
  - a. The machine or equipment effectively prevents the worker from fouling the adjacent controlled track on the other side of the equipment.
  - b. No part of their person breaks the plane of the rail of the occupied track except on the side of the track outlined above.

**NOTE:** A boom or other equipment extending beyond the body of a roadway maintenance machine or coupled equipment toward an adjacent controlled track is not considered to be within the perimeter of the machine or coupled equipment.

- (b) On-ground roadway workers engaged in a common task on an occupied track with On-Track, self-propelled equipment or coupled equipment consisting exclusively of one or more of the following types of equipment:
1. A Hi-rail vehicle or other rail bound vehicle (other than catenary maintenance tower vehicle) being used for inspection or minor correction purposes, provided that such vehicle is not coupled to one or more railroad cars. If multiple hi-rail vehicles or rail bound vehicles are used for inspection or minor correction are engaged in a common task, the on track safety job briefing must include the nature of work to be performed to determine if adjacent controlled track on track safety is necessary.
  2. An automated inspection car being used for inspection or minor correction.
  3. A catenary maintenance tower car or vehicle, provided that all of the on-ground workers engaged in the common task are positioned within the gage of the occupied track for the sole purpose of applying or removing grounds.

## **764. Roadway Maintenance Machines Fouling Adjacent Tracks**

A component of a roadway maintenance machine shall not foul an adjacent track unless:

- (a)** Working limits have been established on the adjacent track, and
- (b)** No movements are permitted within the working limits by the RWIC that would affect any of the roadway workers engaged in a common task with such machine.

## **765. Adjacent Controlled Track “Job Briefing”**

The RWIC of a roadway work group must perform a job briefing prior to operating on the same occupied track with a separate roadway work group subject to the adjacent controlled track On-Track safety requirements (or vice-versa) to determine if adjacent controlled track On-Track safety is necessary. The RWIC shall make this determination.

If the groups are in such proximity that the ability of the roadway workers of the excepted group to hear or see approaching movements is impaired by background noise, lights, sight obstructions or any other physical conditions caused by the equipment then adjacent controlled track On-Track safety must be obtained by both working groups.

# ***INDIVIDUAL TRAIN DETECTION***

## **780. On-Track Safety Procedures for Lone Workers**

A lone worker who fouls a track while performing routine inspection or minor correction work may use Individual Train Detection to establish On-Track safety only as prescribed in this rule.

## **781. Individual Train Detection Selection**

A lone worker retains the right to use On-Track safety procedures other than individual train detection if he deems it necessary, and to occupy a place of safety until a different form of On-Track safety can be established.

## **782. Use of Individual Train Detection**

Individual train detection can be used to establish On-Track safety only:

- (a)** By a lone worker that has been qualified to do so.
- (b)** While performing routine inspection and/or minor correction work.
- (c)** On a track outside the limits of a manual interlocking, a controlled point (except those consisting of signals only), or a remotely controlled hump yard facility.
- (d)** Where the lone worker is able to visually detect the approach of a train, engine, or other railroad equipment moving at maximum authorized speed on that track, and move to a previously determined place of safety not less than 15 seconds before the train, engine, or other railroad equipment would arrive at the location of the lone worker.
- (e)** Where no power-operated tools or roadway maintenance machines are being used in a manner that impairs the hearing of the lone worker.
- (f)** Where the ability of the lone worker to hear and see approaching trains, engines, and other railroad equipment is not impaired by background noise, lights, precipitation, fog, passing trains, or any other physical conditions.

Individual train detection must not be used to provide on-track safety for a lone worker using a roadway maintenance machine, equipment, or material that cannot be readily removed from the track by hand. *Revised 4/1/17*

### **783. Individual Train Detection Place of Safety**

The place of safety to be occupied by a lone worker upon the approach of a train, engine, or other railroad equipment may not be on or fouling a Controlled Track, unless working limits are established on that track.

### **784. Lone Worker Positioning**

The lone worker using individual train detection for On-Track safety while fouling a track may not occupy a position or engage in any activity that would interfere with that worker's ability to maintain a vigilant lookout for and detect the approach of a train, engine, or other railroad equipment moving in either direction.

### **785. Recording Individual Train Detection**

A lone worker using individual train detection to establish On-Track safety must first complete a written **Statement of On-Track Safety (NS Form 11970)**. The Statement must designate the limits of the track for which it is prepared, and the date and time for which it is valid. The Statement must show the maximum authorized speed of trains within the limits for which it is prepared, and the sight distance that provides the required warning of approaching movements. The lone worker using individual train detection to establish On-Track safety must produce the Statement of On-Track Safety when requested by a representative of the Federal Railroad Administration or a supervisor of Norfolk Southern.

# USE AND OPERATION OF ON-TRACK EQUIPMENT

## 800. Responsibilities; On-Track Equipment

Operator or employee in charge of On-Track equipment will be responsible for its safe movement and proper operation.

## 801. Use of On-Track Equipment

- (a) On-Track equipment will be used only for Company business.
- (b) Without proper authority, no one but employees of the Company, in the discharge of their duties, will be permitted to ride On-Track equipment.
- (c) Employees occupying moving On-Track equipment must be securely positioned and braced at all times to avoid injury in the event of a sudden stop. They must occupy a seat when available.
- (d) On-Track equipment shall not be overloaded with tools or material, and such items must be placed away from moving parts and secured.

## 802. Equipment Inspection

- (a) Foremen have overall responsibility, and operators have immediate responsibility, for inspecting and maintaining equipment assigned to them.
- (b) Before On-Track equipment is placed in service, daily inspection must be made for loose bolts, missing cotter keys, fuel leaks, improper brake adjustment, improper wheel gauge, worn wheels, and other items as instructed.
- (c) Brakes must be examined each day before using On-Track equipment. When equipment is placed on track, a running test of brakes must be made immediately after starting.
- (d) On-Track equipment should be serviced during daylight hours if possible.

## 803. Flagging Equipment

Operator or employee in charge must have fusees, a red flag by day and a white light at night ready for immediate use, separate from tools and materials. Fusees must be carried in an approved metal container.

## 804. Protecting Work Locations

Qualified employees assigned to protect work locations of construction or private contractors whose operations may affect the safe movement of trains or engines must take the following actions:

- (a) Secure proper signaling equipment and operable radio.
- (b) Upon reporting for work each day:
  1. Determine who is in charge of the workers.
  2. Ensure all workers have been instructed not to foul any track at any time without permission.
- (c) If workers fail to comply with the instructions of the qualified employee or an event occurs that would interfere with the safe passage of trains or engines, the qualified employee, using radio communication, must immediately:
  1. Stop any approaching trains or engines.
  2. Notify the Train Dispatcher or Yardmaster.

## 805. Protection on Controlled Track

- (a) Before On-Track equipment enters or fouls controlled track, employee in charge must obtain authority from Control Station. Authority must be written on Track Authority Form and repeated to Control Station for confirmation. Authority must specify time, limits and tracks to be used, and will be made known to employees accompanying equipment.
- (b) The Control Station must inform the person who obtains limits that:
  1. Blocking is applied to the control machine.
  2. The intended movement has been recorded on the prescribed form.

If such confirmation is not given, the person obtaining working limits must ask for and receive it before movement begins.
- (c) On-Track equipment must clear specified tracks not later than specified time, unless the time is extended on authority of the Control Station.
- (d) When occupying Controlled Track, On-Track equipment must not pass the home signal in direction of movement at either end of the limits without additional authority.

- (e) Clearing for time limit or at direction of Control Station voids authority. After clearing, the person who obtained the working limits must report clear to Control Station.

## **806. Joint Occupancy of Working Limits**

- (a) Joint occupancy of working limits is permitted for On-Track equipment or roadway workers without notifying the Train Dispatcher:
1. In territory governed by **Rule 251** and **Rule 261**, when authorized by the employee in charge of time and working limits.
  2. In territory governed by **Rule 171** and **Rule 271**, when authorized by the employee named in a Track Authority authorizing a “WORK BETWEEN” two specific points.
- (b) Before granting authority for joint occupancy, the employee who obtained the original time and working limits or Track Authority from the Train Dispatcher will be responsible for recording on the prescribed form:
1. The name of the employee receiving authority for joint occupancy.
  2. The limits of joint occupancy and time authorized.
- (c) The employee receiving authority for joint occupancy of working limits must be qualified as a Roadway Worker in Charge. The employee receiving authority for joint occupancy must record and repeat from written copy off the prescribed form to the employee in charge:
1. Track Authority Number.
  2. The limits of joint occupancy.
  3. Tracks to be used.
  4. Any restrictions that may be in effect.
- (d) The employee who obtained the original Track Authority from the Train Dispatcher is responsible for ensuring that all men and equipment have cleared the limits before the Track Authority is voided. When releasing working limits to the Train Dispatcher the employee holding authority shall state the name of each



employee that he/she has authorized to jointly occupy the working limits and the time each cleared.

- (e)** When releasing working limits to the Train Dispatcher, the employee holding authority must:
1. State the name of each employee that was authorized to jointly occupy the working limits and the time each cleared, or
  2. Notify the Train Dispatcher that no employees have been granted authority to jointly occupy the working limits.

The Train Dispatcher must not consider the Track Authority limits “clear” until this information is received from the reporting employee.

*Revised 4/1/17*

## **807. Permission on Non-Controlled Tracks and Rule 251 Territory**

- (a)** At locations where a Yardmaster or Train Dispatcher is responsible for directing train and engine movements, Roadway Workers, and Operators of On-track equipment must have permission in writing prior to occupying or establishing Working Limits of Inaccessible Track on any non-controlled track:

1. Such as yard tracks, or similar auxiliary tracks.
2. The main track within Rule 93 “Yard Limits”.

This permission must be copied on the Yard Permission (YP) form and may extend beyond the date entered on the form. Once cleared, the YP form must be retained until the end of the next tour of duty.

- (b)** The Yardmaster or Train Dispatcher must not authorize any conflicting movements within the limits specified in the YP Form until all parties are informed of the movement(s) to be made. At locations where ABS signals provide signal aspects more favorable than an approach signal, train and engine movements

must not be permitted to operate within main track Yard Limits where a Yard Permission (YP) form is in effect.

- (c)** In Rule 251 Territory, the Train Dispatcher may authorize the operation of On-Track equipment. Protection may be provided by controlled signal or by withholding the authority for operation of trains and engines. The Train Dispatcher will be responsible for insuring that the affected track section is clear and maintained clear of conflicting movements.
- (d)** When roadway maintenance machines are engaged in weed spraying and snow removal on non-controlled track:
1. Working limits of inaccessible track are not required to be established.
  2. All train, engine, and roadway maintenance machine movements must operate at Restricted Speed.
  3. Humping operations must not be in effect where the roadway maintenance machines are operating.
  4. Flat switching operations (kicking of cars) must not be in effect where the roadway maintenance machines are operating, unless the roadway worker in charge specifically agrees in a Job Safety Briefing with the controlling party to permit it.
  5. Specific devices on the roadway maintenance machines must be operable and used as follows:
    - An operative 360-degree intermittent warning light or beacon,
    - Work lights, if the machine is operated during the period between one-half hour after sunset and one-half hour before sunrise or in dark areas such as tunnels, unless equivalent lighting is otherwise provided,
    - An illumination device, such as a headlight, capable of illuminating obstructions on the track ahead in the direction of travel for a distance of 300 feet under normal weather and atmospheric conditions;

- A brake light activated by the application of the machine braking system, and designed to be visible for a distance of 300 feet under normal weather and atmospheric conditions;
- A rearward viewing device, such as a rearview mirror.

*Revised 9/29/17*

## **808. Non-Interlocked Railroad Crossing at Grade**

At non-interlocked railroad crossings at grade, all On-Track equipment must stop short of the crossing and must not proceed over it until the way is seen to be clear.

## **809. Insulated On-Track Equipment**

Insulated On-Track equipment (which does NOT shunt track circuits) must stop short of interlocked railroad crossings at grade. If power switches or derails will be traversed, it must be arranged for the Control Station to protect the route. Then when the way is seen to be clear, movement may proceed.

## **810. Non-Insulated On-Track Equipment**

Except as provided in Rule 808, operation of On-Track equipment within interlocking limits will be governed as follows:

- CONTROLLED INTERLOCKINGS (C) — by provisions of **Rule 276**
- AUTOMATIC INTERLOCKINGS (A) — by provisions of **Rule 276**

## **811. Fouling of a Railroad Crossing at Grade**

On-Track equipment must not stand fouling a railroad crossing at grade unless protection has been provided.

## **812. Speed of On-Track Equipment**

- (a) On-Track equipment must at all times be prepared to stop within half the range of vision.
- (b) Passenger type Hi-Rail vehicles 10,000 lbs. or less gross vehicle weight (GVWR), must not exceed 35 MPH. Other On-Track equipment must not exceed 30 MPH.
- (c) Use of cruise control is prohibited when operating On-Track equipment on the rail.

- (d) Speed must be adjusted when stopping distance is affected by conditions such as grade, load, or rain, frost or grease on the rail.
- (e) Care must be taken to avoid striking anything lying on or across the rail.

### **813. Highway Grade Crossings; Warning Devices**

- (a) On-Track equipment approaching a highway grade crossing must be prepared to stop short and must not enter the crossing until the way is known to be clear.
- (b) On-Track equipment must not be operated over a crossing protected by manually-operated gates or by a watchman until gates are down or watchman is in position to protect movement.
- (c) Warning devices, where provided, must be sounded when:
  1. Passing passenger stations.
  2. Moving through tunnels.
  3. Approaching and passing over grade crossings.
  4. Approaching anyone on or near the track.
  5. Other times when necessary to give warning.

### **814. Operating With Caution**

- (a) On-Track equipment must be operated with caution when moving over switches and frogs, through tunnels, over bridges, and while passing anyone on or near the track. Before reversing direction, the operator must give a warning signal and know the way is clear.
- (b) Equipment must not be run between a standing passenger train and the platform that passengers are using.

### **815. Vigilant Lookout; Conduct**

Each employee must assist the operator in keeping vigilant lookout for trains, other equipment or obstructions, on or off the track, including people, vehicles, animals, contractors' equipment or anything that could affect safe movement.

While in motion, operators and occupants of equipment must remain vigilant, not engage in unnecessary conversation or in boisterous conduct while equipment is in motion.

## 816. Shunting

Rail test cars and similar On-Track equipment cannot be depended on to actuate automatic block or highway crossing signals.

## 817. Moving Against the Current of Traffic

Where two or more tracks are signaled for movement with the current of traffic, equipment must not move against the current of traffic except under flag protection or by arrangement with Train Dispatcher for protection.

## 818. Proper Spacing between On-Track Equipment, Roadway Maintenance Machines, and Employees

- (a) Roadway Maintenance Machines and On-Track equipment must not follow nearer than 600 feet behind a train or engine moving on main track, and must not approach a standing train or engine nearer than 200 feet except when necessary to clear.
- (b) Two or more units of Roadway Maintenance Machines or On-Track equipment moving in the same direction must be sufficiently spaced to prevent accident. Before stopping or slowing down, occupants of each unit must signal those following.
- (c) When working, Roadway Maintenance Machines must maintain 25 feet of separation from other Roadway Maintenance Machines or equipment working in the foul of the track. When necessary, Roadway Maintenance Machines may work closer than 25 feet provided that the operators conduct a job safety briefing and all involved have a clear understanding of the movements to be made.
- (d) Employees must maintain 25 feet of separation in front of and behind Roadway Maintenance Machines. When necessary, employees may work closer than 25 feet provided that the employee(s) and machine operator conduct a job safety briefing and all involved have a clear understanding of the movements to be made.

Before an employee enters the swing radius of a roadway maintenance machine equipped with a boom, the following additional precautions must be taken:

1. Eye contact or other form of communication must be established between the employee(s) and the operator of the machine/equipment.
2. The operator must receive communication from the employee(s) indicating that the employee(s) desires to enter the swing radius.
3. The operator must stop all movement, place the machine/equipment in neutral when safe to do so, and remove their hands from the controls of the machine/equipment. This will indicate it is safe for the employee(s) to enter the immediate area.
4. Movement of the machine/equipment may resume while the employee(s) is in the swing radius of the machine, only after the movements to be made have been clearly communicated between the employee(s) and the operator. If the view of the operator becomes obstructed, machine movements must stop until an unobstructed view of the employee(s) is re-established.

*Revised 7/5/17*

## **819. Securing On-Track Equipment**

- (a) Unattended On-Track equipment either on or off the rail must be secured, locked, and left clear of all tracks that are in service without blocking view from crossings.
- (b) Equipment standing on grades must be properly secured.

## **820. Operation at Night**

On-Track equipment operating at night must display a white light to the front and a red light to the rear when so equipped.

## **821. Approaching Trains**

In signaled territory, employee in charge and all occupants of On-Track equipment must observe block signals and know the location of an approaching train causing signal indication to change.

## **822. Drawbridges**

Approaching drawbridges, On-Track equipment must stop before reaching rail joints that connect running rails with drawspan, and joints must be inspected to know that bridge is locked in place before proceeding.

## **823. Riding Equipment; Adjustments**

- (a)** On moving equipment, occupants must not stand, hang legs over side, sit on one machine with feet on another, ride between machines in any way, step from one machine to another, or change from one location to another.
- (b)** Adjustments to motors of On-Track equipment must not be attempted while in motion.

## **824. Repairs to Equipment**

Adjustment or repair of On-Track equipment is prohibited when any employee could contact or be caught by moving parts. Before attempting repair, the equipment must be shut off and locking devices, where provided, must be applied.

## **825. Rail Sweeps**

Rail sweeps, where provided, must be frequently inspected, kept in good repair, and kept in sweep position when equipment is in motion. The equipment should not be operated in reverse except in emergency or for short moves.

## **826. Pushing, Towing, Coupling Equipment**

- (a)** On-Track equipment must not push or tow similar equipment except in case of necessity, and then only when coupled with prescribed rigid coupler and safety pins. Employees must not ride on a pushcar or pole car being pushed or towed, or go between any coupled equipment while in motion.
- (b)** When units of On-Track equipment are to be coupled, 1 unit must be standing, and everyone but operator of the moving unit must stand clear until the moving unit stops in approximate coupling position. Only then may the employee who will make coupling step between units and signal operator to move as necessary to complete coupling.

## 827. Fuel Tanks; Open Flames; Cooling Systems

- (a) Fuel tanks must not be filled or drained inside any building or while motor is running. Tanks must not be drained in or near cars, depots or platforms.
- (b) Open flame or burning material must not be used to warm cylinders or manifolds when starting motors.
- (c) Gasoline must not be carried on equipment except in a labeled SAFETY CAN bearing UL or FM logo.
- (d) Care must be taken to see that cooling system is protected and does not freeze.

## 828. Switch-Derail Position

- (a) The position of a switch or derail being used is the responsibility of the operator of equipment using the switch or derail.
- (b) When a main track switch has been lined for movement of On-Track equipment or for other reason, the switch must be restored to normal position, locked, and the lock must be tested. Before departing, On-Track equipment must, if possible, make a facing-point movement over the switch to make sure it is properly positioned.
- (c) Spring switches must be operated by hand when necessary to move equipment through them.

## 829. Operation of FRA Track Geometry Car, Sperry Rail Test Cars, and Rail Grinders

### (a) FRA Track Geometry Car:

1. Will be operated on signal indication, and
2. The Control Station must provide protection against opposing and following trains in the same block at all times.
3. On-Track equipment may follow under provisions of Roadway Worker Protection rules.
4. **Rule 276** applies.

### (b) Sperry Rail Test Cars and Rail Grinders:



1. While testing or working:
  - a. The Control Station must provide working limit protection against opposing and following trains in the same block at all times.
  - b. On-Track equipment may occupy the same block under provisions of Roadway Worker Protection rules.
  - c. Rules governing the operation of On-Track equipment apply.
2. While tramming:

When piloted by a Transportation Department employee for the purpose of an overhead movement (not engaged in testing or working), the movement will be governed by signal indication and/or a Track Authority Form. In **Rule 261** territory, blocking protection must be provided behind the movement at all times. Speed must not exceed 30 MPH or the maximum authorized freight train speed, whichever is less, and an absolute block must be maintained.

## **CAMP CARS**

### **840. Protection of Occupied Camp Cars**

These rules prescribe the procedures for the protection of railroad employees when they are in, around, or in the vicinity of camp cars parked for the purpose of housing them. These rules do not apply to camp cars while the cars are in a train.

### **841. Restrictions**

Once an Occupied Camp Car Signal has been displayed, the following restrictions apply:

- (a) The camp cars must not be coupled to or moved.
- (b) Equipment must not be placed on the same track in a manner that reduces or blocks the view of the signal.
- (c) Equipment must not pass the signal.
- (d) Only a designated occupant of the camp cars or his/her immediate supervisor may remove the signal.

### **842. Responsibilities of Camp Car Occupant/Supervisor**

#### **(a) Other than a main track**

When camp cars are parked on a track for the purpose of housing railroad employees, a designated occupant of the camp cars or his/her immediate supervisor must take the following actions as soon as the engine has been detached from the cars:

1. Notify the employee in charge of the track on which the camp cars are parked.
2. Line each hand-operated switch providing access to the track against movement to the track; spike and lock each switch with an effective locking device.

**EXCEPTION:** A derail locked in derailing position with an effective locking device may substitute for the hand-operated switch requirement. The derail must be positioned no less than 150 feet from the end of the camp cars where maximum authorized speed is greater than 5 MPH and no less the 50 feet from the camp cars where maximum authorized speed is not more than 5 MPH.

3. Request and receive protection from the employee controlling any remotely controlled switches that provide access to the track.
4. Display an Occupied Camp Car Signal at each of the switch and/or derail locations mentioned above.

**(b) On a main track**

1. Notify the employee in charge of the track on which the camp cars are parked.
2. Position a derail locked in the derailing position with an effective locking device no less than 150 feet from the end of the camp cars.
3. Line each hand-operated switch providing access to the track against movement to the track; spike and lock each switch with an effective locking device.
4. Request and receive protection from the employee controlling any remotely controlled switches that provide access to the track.
5. Display an Occupied Camp Car Signal at each of the switch and/or derail locations mentioned above.

**843. When Camp Cars are to be Moved**

- (a) Notify camp car occupants.
- (b) Remove spikes, locks, derails, and Occupied Camp Cab Signals.
- (c) Notify the employee in charge of the track.
- (d) Notify the employee controlling the remotely controlled switches providing access to the track.
- (e) Camp cars must not be humped or flat yard switched with motive power detached.

#### **844. Responsibilities of Employee Controlling Remotely Controlled Switches**

When requested to provide protection, the employee controlling remotely controlled switches providing access to the track where camp cars are parked must line the switches against movement to the track and apply blocking devices. The employee must not remove the blocking devices until the person in charge of the camp car occupants advises him/her that protection is no longer required. The employee controlling the switches must record:

- time
- date
- track
- craft
- employee names(s)

Protection must be maintained until the track is reported unoccupied and released. This record must be maintained for 15 days following the date of removal.

# REMOTE CONTROL LOCOMOTIVES

## 850. Remote Control Guidelines

- (a) Each employee who operates a Remote Control Locomotive must be certified and qualified in accordance with 49 CFR 240.
- (b) Prior to the beginning of each job or when conditions change, a Job Safety Briefing must be conducted.
- (c) When “3-Step Protection” is required, the Remote Control Operator must:
  1. Place the OCU speed control in the STOP position.
  2. Place the directional control in neutral.
  3. Apply the locomotive brake and if the air is coupled and cut in, the automatic brake.

“3-Step Protection” must not be released by the RCO until each employee who has requested protection has advised that they are in the clear.

- (d) Each Remote Control Operator must have:
  - an approved vest, and
  - an operative, holstered hand-held radio equipped with an external microphone
- (e) While performing duties, the RCO must wear the vest and harness with the OCU properly attached and turned “On”.

The OCU and harness must not be altered or worn in any manner that would negate the OCU tilt feature.

- (f) All Remote Control movements are considered shoving movements, except when the RCO is riding the lead locomotive in direction of movement in position to visually observe conditions ahead.

When initiating a Remote Control shoving movement:

1. The RCO must visually determine the direction of movement, or a crewmember must visually determine the direction of movement and confirm with the RCO.
2. If confirmation of direction of movement is not received, the movement must be immediately stopped.

(g) No more than the equivalent of 12 powered axles may be used to make a shove movement or back-up movement with Remote Control Locomotives.

**EXCEPTION:** The equivalent of 18 powered axles may be used to make a shove movement or back-up movement with Remote Control Locomotives in compliance with special instructions at the following hump classification yards:

<b>DIVISION</b>	<b>HUMP CLASSIFICATION YARD</b>
Lake	Bellevue
Georgia	Macon
Piedmont	Linwood
Alabama	Birmingham

The provisions of **NS-1, Rule L-242** “Back Up Movement” and **NS-1, Rule L-248** “Helper/Pusher Service” remain in full force.

- (h) The Remote Control Operator on a Remote Control assignment must apply the prescribed tag on the throttle indicating the locomotive is being used in a Remote Control mode. The Remote Control Operator who applied the tag must remove it when the locomotive is placed in manual mode.
- (i) A remote Control Operator must not operate the RCL while riding in a vehicle or on equipment (other than the RCL or equipment coupled to the RCL.)
- (j) A Remote Control Operator may operate only 1 RCL consist at a time.
- (k) Remote Control Operators will advise their immediate supervisor of any problems or malfunctions with the Remote Control equipment or system.

### **851. Setup and Testing**

- (a) Prior to operating an OCU, the RCO must ensure the equipment is properly setup and tested in accordance with prescribed procedures. If 2 OCUs are to be utilized, each unit must be tested.
- (b) When an RCO relieves another RCO, the relieving RCO must test the equipment in accordance with the prescribed procedures.

## 852. Securing Equipment

- (a) When a Remote Control Locomotive is left unattended, the locomotive must be secured in the following manner:
1. Secure locomotive as prescribed in **NS-1, Rule L-236**.
  2. Turn off each OCU programmed to the RCL.
  3. If going off duty, place the RCL in manual operation mode unless another RCO is physically present to take control of the RCL.
  4. Store and secure the OCU properly or maintain in the RCO's immediate possession.
- (b) When Blue Signal Protection of the Remote Control Locomotive is required, the RCL must be placed in the manual mode and properly secured.
- (c) Car(s) left standing must be secured with hand brakes as required by **Operating Rule 225** "Hand Brake Requirements".

**EXCEPTION:** At locations authorized by Timetable Instructions, equipment consisting of Remote Control Locomotive(s) coupled to car(s) may be secured by applying the remote controlled parking brake on the lead or controlling locomotive/slug. When authorized, the OCU will be left on and programmed to the RCL.

## 853. Remote Control Areas

- (a) Protection provided by Blue Signal or Roadway Worker Protection Rules will remain in full force.
- (b) The RCO in control of a Remote Control Locomotive must be notified of any track removed from service or working limits established for the protection of another craft.

## 854. Remote Control Zones

Train, engines and On-Track equipment must receive permission from the designated authority before occupying or fouling a RCZ.

### (a) Activating Remote Control Zones

1. The RCO must contact the designated authority to activate a RCZ. The RCO must repeat this information to the designated authority that will record the information and, if correct, provide the RCO with an activation time.

2. The designated authority will not authorize any movement to enter an activated RCZ.

### **(b) Deactivating Remote Control Zones**

1. The RCO must contact the designated authority to deactivate the RCZ:
  - a. When work is complete in the RCZ, or
  - b. When it is necessary to authorize another movement or worker to jointly occupy the zone, or
  - c. Prior to going off duty.
2. The designated authority will provide the RCO a deactivation time and record the information on the proper form. The RCO must repeat this information.

### **(c) Operating within Activated Remote Control Zones**

1. When making shove movements within an activated RCZ, after the Remote Control crew has made an initial visual determination that:
  - there is sufficient room in the track to hold the equipment being shoved, and
  - there are no conflicting movements, and
  - intervening road crossings are properly protected, and
  - intervening switches and derails are properly lined for the intended movement
2. Subsequent determinations that the track is clear are not required provided:
  - the shove movement is being made solely within an activated RCZ
  - the controlling locomotive of the Remote Control movement is on the leading end in the direction of movement
  - the RCZ is not jointly occupied

## **855. Daily Inspection Procedures**

### **(a) Remote Control Locomotive**

1. Daily inspection interval requirements of an RCL are the same as those of a conventional locomotive.



2. Daily inspection brake tests of an RCL must be completed with the locomotive in Remote Control. If the Remote Control System is inoperative at the time of the daily inspection brake test, the defect must be noted on the locomotive daily inspection report.
3. If the Remote Control equipment permanently mounted to the locomotive becomes defective, the defect must be noted on the locomotive daily inspection report.

**(b) Operator Control Unit**

1. When operating the Remote Control Locomotive, the OCU is an appurtenance to the locomotive.
2. An OCU found to be defective at any time may not be used.
3. A defective OCU does not need to be reported on the locomotive inspection report.
4. A defective OCU must be immediately removed from service, tagged, and reported to the proper authority.

**856. Proper Handling and Securement of OCUs**

**(a) The employee using the OCU:**

1. Is responsible for its proper use and handling.
2. Must sign the device out on the OCU Control and Transfer Form at the beginning of his/her tour of duty.
3. Must sign the device in on the OCU Control and Transfer Form at the completion of his/her tour of duty.

**(b) The OCU when not in use must be:**

1. Kept at a secure location specified by special instructions.
2. Stored in a designated locked storage area with the power off and battery removed.

**(c) When the OCU is transferred to another Remote Control Operator, the employee being relieved must make a notation on the OCU Control and Transfer Form of the:**

1. Name of the relieving employee.
2. Date.
3. Time.

**NOTE:** The Hours of Service must not be exceeded when entering the required information.

- (d) The unauthorized removal from company property or disposal of an OCU is prohibited.

### **857. Pullout Stopping Protection**

- (a) Each time a movement enters a track equipped with PSP; the RCO must monitor the designated radio channel for the PSP talker message or observe the OCU digital display to confirm that the PSP is active. If the talker message is unclear the RCO can listen to the talker messages using the status switch on the OCU.
- (b) If the PSP is not active the RCO must immediately STOP the movement and the designated authority must be notified. When authorized, movements may resume in accordance with applicable rules.

# AUTOMATED PROCESS-CONTROLLED HUMP YARDS

## *HUMPING OPERATIONS*

### 870. Humping

The first (5) five cars humped into a clear track must be made in single car cuts.

**NOTE:** Only applies to Hump Yards equipped with Train Yard Tech.

*Revised 7/5/17*

## *PULLBACK OPERATIONS*

### 875. Equipment beyond the Skate Retarders

**(a)** No equipment may be left:

- Beyond the “Take Action” point on the pullback end of any classification track, unless the equipment is properly secured by the Skate Retarder or with handbrakes, and the Yardmaster has applied protective blocking to the process control system to prevent additional equipment from being humped into the track.
- Between the “Take Action” point and the Skate Retarder on the pullback end of any classification track unless properly secured.

**(b)** Employees who observe equipment beyond the “Take Action” point, or standing between the “Take Action” point and Skate Retarder and not properly secured, must immediately notify the Yardmaster. The Yardmaster must promptly apply protective blocking to the track to prevent additional equipment from being humped into the track, arrange to have the equipment secured and, if applicable, repositioned in the clear of the “Take Action” point.

**(c)** The “Take Action” point is indicated by white reflective markers on the cross-tie. If the “Take Action” point is not present or visible, it will be considered 100 feet (2 car lengths) beyond the Skate Retarders.

*Revised 7/1/15*

# DEFINITIONS

**Absolute Block** — A block which may be occupied by only 1 train or engine at a time.

**Adjacent Tracks** — Two or more tracks with track centers spaced less than 25 feet apart.

**Automatic Block Signal** — A block signal that is activated either by track circuit or in conjunction with interlocking or controlled point circuits. This block signal automatically indicates track condition and block occupancy.

**Automatic Block System (ABS)** — A series of consecutive blocks governed by block signals, actuated by a train or engine, or by certain conditions affecting the use of a block.

The use of each block may be governed by an Automatic Block Signal, Cab Signal, or both.

**Block** — A length of track of defined limits on which train movements are governed by block signal, cab signal, or mandatory directive. In signaled territory, a block is the track section between 2 consecutive block signals governing movement in the same direction.

**Block Signal** — A fixed signal at the entrance of a block to govern trains and engines entering and using that block

**Blocking Device** — A method of control that either prohibits the operation of a switch or signal or restricts access to a section of track

**Blue Signal Protection** –

**Blue Signal** — A clearly distinguishable blue flag, blue light, or blue tag by day, or a blue light, or blue tag by night. When displayed, it signifies that workers are on, under or between equipment. When attached to the operating controls of a locomotive, it need not be lighted if the inside of the cab area of the locomotive is sufficiently lighted to make the blue signal clearly distinguishable.

**Rolling Equipment** – Includes locomotives, railroad cars, and one or more locomotives coupled to one or more cars.

**Servicing** – Pertains to sanding, adding lubricant oil, etc., but does not include supplying cabooses, locomotives, or passenger cars with items such as ice, drinking water, tools, sanitary supplies, stationary, or signaling equipment.

**Switch Providing Access** – A switch which if traversed by rolling equipment could permit that rolling equipment to couple to the equipment being protected

**Workman** – railroad employee assigned to inspect, test, repair, or service railroad rolling equipment or their components including brake systems.

**Workmen, Group of** – Two or more workmen of the same or different craft(s) assigned to work together as a unit under a common authority and who are in communication with each other while the work is being done.

**Cab Signal** — A signal located in the operating compartment of the controlling locomotive indicating track occupancy or condition. The cab signal is used with interlocking signals, controlled point signals, block signals, or both.

### **Camp Cars — Occupied**

**Camp Car** — Any On-Track vehicle, including outfit, camp, bunk or office cars or modular homes mounted on flat cars used to house railroad employees, not including wreck trains.

**Effective Locking Device** — (See definition for Effective Securing Device)

**Rolling Equipment** — Includes locomotives, railroad cars, and one or more locomotives coupled to one or more cars.

**Switch Providing Access** — A switch which if traversed by rolling equipment could permit that rolling equipment to couple to the equipment being protected.

**Warning Signal** — A white disk with the words “Occupied Camp Car” in black lettering during daylight hours and in addition an illuminated white signal at night, indicating that employees are in, around, or in the vicinity of camp cars.

**Clearance Point** – The location on a track nearest the switch that does not obstruct the movement of equipment on adjacent tracks, including, where permitted, a person riding the side of the equipment.

**Control Station** — A place from which a signal system or a controlled point / interlocking is operated.

**Controlled Point (CP)** — A station designated in the Timetable where signals are controlled from the Control Station.

**Controlled Point/Interlocking Limits** — The tracks between opposing home signals.

**Controlled Signal** — A fixed signal, controlled by a Train Dispatcher, capable of displaying a Stop indication.

**Controlled Track** — A track upon which all movements of trains, engines, and On-Track equipment must be authorized by a Control Station.

**Crossover** — A combination of 2 switches connecting 2 adjacent tracks. When lined, this switch combination allows movements to cross from one track to the other.

**Current of Traffic** — The assigned direction of movement on a main track governed by Rule 251, as specified in the Timetable.

**Derail** — A track device designed to guide equipment off the rails at a selected location as a means of protection.

**Distant Signal** — A fixed signal that governs approach to the next signal.

**District** — A portion of a division designated by Timetable.

**Division** — That portion of a railroad assigned to the supervision of a Division Superintendent.

**Dual-Control Derail** — A power-operated derail also equipped for hand operation.

**Dwarf Signal** — A low controlled point/interlocking or block signal.

**Effective Securing Device** — A vandal and tamper resistant lock, keyed for application and removal only by the class, craft, or group of employees for whom the protection is provided

For Roadway Workers in the absence of a lock, it is acceptable to use a spike driven firmly into a switch tie or a switch point clamp to prevent the use of a manually operated switch. It is also acceptable to use portable derails secured with specifically designed metal wedges. Securing devices without a specially keyed lock must be designed in such a

manner that they require railroad track tools for installation and removal and the operating rules of the railroad must prohibit removal by employees other than the class, craft, or group of employees for whom the protection is being provided. Regardless of the type of securing device, the throwing handle or hasp of the switch or derail shall be uniquely tagged. If there is no throwing handle, the securing device shall be tagged. *Revised 4/1/17*

**Engine** — A unit propelled by any form of energy, or a combination of such units operated from a single control, used in train or yard service.

**Engine Service Employees** – Engineers, locomotive Engineer trainees (LET's), hostlers and hostler helpers.

**Equipment** – Locomotives, Railcars, Triple Crown Trailers, and On-Track equipment.

**Exclusive Track Occupancy** — A method of establishing working limits on controlled track in which movement authority of trains, engines, or other railroad equipment is withheld by the Train Dispatcher, or restricted by flagmen as prescribed by rule.

**Fixed Signal** — A signal of fixed location indicating a condition affecting the movement of a train or engine.

**Fouling a Track (Equipment)** – When the end of equipment is between the clearance point and the switch points leading to the track on which the equipment is standing.

### **Heavy Grade**

For a train operating with 4,000 trailing tons or less, a section of track with an average grade of 2% or greater over a distance of 2 continuous miles.

For a train operating with greater than 4,000 trailing tons, a section of track with an average grade of 1% or greater over a distance of 3 continuous miles.

### **Highway-Rail Grade Crossing Warning System**

**Activation Failure** — The failure of an active highway-rail grade crossing warning system to indicate the approach of a train at least 20 seconds prior to the train's arrival at the crossing, or to indicate the presence of a train occupying the crossing, unless the crossing is provided with an alternative means of active warning to highway



users of approaching trains. (This failure indicates to the motorist that it is safe to proceed across the railroad tracks when, in fact, it is not safe to do so.) A grade crossing signal system does not indicate the approach of a train within the meaning of this paragraph if — more than 50% of the flashing lights (not gate arm lights) on any approach lane to the crossing are not functioning as intended, or in the case of an approach lane for which two or more pairs of flashing lights are provided, there is not at least 1 flashing light pair operating as intended. Back lights on the far side of the crossing are not considered in making these determinations.

**Appropriately Equipped Flagger** — A person other than a train crewmember who is equipped with a Norfolk Southern approved flagging vest, shirt, or jacket along with approved hand signal flagging devices, which include “STOP/SLOW” paddles or red flags for daytime flagging and a flashlight, lantern, or other lighted signal for nighttime flagging.

**Credible Report of System Malfunction** — Specific information regarding a malfunction at an identified highway-rail crossing, supplied by a railroad employee, law enforcement officer, highway traffic official, or other employee of a public agency acting in an official capacity.

**False/Partial Activation** — The activation of a highway-rail grade crossing warning system caused by a condition that requires correction or repair of the grade crossing warning system. (This failure indicates to the motorist that it is not safe to cross the railroad tracks when, in fact, it is safe to do so.)

**Warning System Malfunction** — An activation failure or false activation of a highway-rail grade crossing warning system. (**NOTE:** “Activation Failure” includes, without limitation, when it is known that effective shunting is being prevented by sand, rust grease, or other foreign matter on the rail.)

**Home Signal** — A fixed signal, capable of displaying a STOP indication, governing the entrance to a route, block, interlocking or controlled point.

**Hours of Service Limit (HSL)** — The latest time at which an Hours of Service employee can perform service without violating the FRA Hours of Service law.

**Imperfectly Displayed Aspect** — A signal aspect not in conformity with applicable signal rules

**Improper Signal** — A signal displaying an aspect more permissive than Block Conditions should allow, or displaying or appearing to display an aspect that the signal is not capable of displaying.

**Interlocking** — An arrangement of signals and signal appliances so interconnected that their movements must succeed each other in proper sequence. An interlocking may be controlled or automatic.

**Controlled Interlocking** — An interlocking operated by a Control Station.

**Automatic Interlocking** — An interlocking actuated automatically by the approach of a train or engine.

Interlockings will be designated in the Timetable.

**Interlocking Appliances** — The parts of an interlocking that are capable of movement such as: switches, derails, movable point frogs, movable bridges, etc.

**Interlocking Signals** — The fixed signals of an interlocking.

**Main Track** — A track, designated by Timetable, upon which movements are authorized by **Rules 93, 171, 251, 261, or 271**.

**Mandatory Directive** — Any movement authority or speed restriction that affects the movement of a train, engine, On-Track equipment, single or in combination with other equipment. Any Form used to authorize use of controlled track is a Mandatory Directive.

**Non-Controlled Track** — A track upon which trains and engines are permitted by rule or special instructions to move without receiving authorization from a Control Station. (**NOTE:** Sidings in **Rule 171** and **271** territories are regarded as non-controlled track; however, must not be blocked unless authorized by the Train Dispatcher.)

**Non-Interlocked Railroad Crossing** — A non-signaled railroad crossing at grade that may be equipped with gates, Stop signs and/or targets and governed by posted or special instructions.

**Non-Signaled Territory** — Territory not equipped with automatic block signal systems.

**On-Track Equipment** — Flanged-wheel equipment, other than trains or engines, propelled manually or by other forms of energy, used in the inspection, maintenance, or construction of track, structures, signals and communication equipment.

**Operations Bulletin** — Instructions issued by the Division Superintendent concerning rules, special instructions or other matters pertaining to operations.

**Personal Electronic Device** — Any electronic or electrical device not provided to the employee by Norfolk Southern for authorized business purposes.

**Pilot** — An employee assigned to a train or On-Track equipment when the Engineer or Operator is not fully acquainted with the physical characteristics or rules of the railroad.

**Railroad-Supplied Electronic Device** — Any electronic or electrical device provided to the employee by Norfolk Southern for authorized business purposes.

## **REMOTE CONTROL OPERATIONS**

**Operator Control Unit (OCU)** – A portable radio transmitter used by the Remote Control Operator (RCO) to send commands to a Remote Control Locomotive (RCL).

**Pullout Stopping Protection (PSP)** – An automated control system for RCL equipped locomotive that provides stopping protection on designated tracks. Tracks equipped with PSP will be designated by Bulletin or Timetable Special Instructions.

**Remote Control Area (RCA)** – An area where Remote Control Locomotives may operate, signs will be erected to identify Remote Control Areas

**Remote Control Locomotive (RCL)** – A Remote Control Locomotive is one which, through use of a radio transmitter and receiver system can be operated by an employee not physically within the confines of the locomotive cab. For purposes of this definition, the term Remote Control Locomotive does not refer to a locomotive or locomotive consist remotely controlled from the lead locomotive of a train in a Distributed Power arrangement.

**Remote Control Operator (RCO)** – An employee who utilizes a portable radio transmitter in connection with operations involving a Remote Control Locomotive (RCL), with or without cars

**Remote Control Receiver (RCR)** – A system on-board a Remote Control Locomotive which receives commands from the Remote Control Transmitter (RCT), processes the commands, and directs the locomotive to execute them.

**Remote Control System (RCS)** – All transmitters and receivers necessary to safely operate and control a Remote Control Locomotive

**Remote Control Zone (RCZ)** – One or more tracks, with defined limits designated by Bulletin or Timetable Special Instructions, where a Remote Control Locomotive may operate exclusively when the zone is activated by the designated authority.

**Return Movement** — A movement of either the locomotive(s) or leading portion of the train, directed back toward the stationary portion of the same train.

**Reverse Movement** — A movement opposite the direction previously authorized.

#### **Roadway Worker Protection –**

**Adjacent Controlled Track (RWP)** – A controlled track whose track center is spaced 19 feet or less from the track center of the occupied track.

**Flagman (RWP)** — When used in relation to roadway worker safety means a qualified employee designated to direct or restrict the movement of trains, engines, or On-Track equipment past a point on a track to provide On-Track safety for roadway workers while engaged solely in performing that function.

**Fouling a Track (RWP)** — The placement of an individual or equipment in such proximity to a track that the individual or equipment could be struck by a train, engine, or other railroad equipment, or in any case is within 4 feet of the field side of the nearest running rail.

**Inaccessible Track (RWP)** — A method of establishing working limits on non-controlled track by preventing entry and movement of trains, engines, or other railroad equipment.

**Individual Train Detection (ITD)** — A procedure by which a lone worker acquires On-Track safety by seeing approaching trains, engines, or other On-Track equipment and leaving the track before

they arrive and which may be used only under circumstances defined by rule.

**Inter-track Barrier (RWP)** – A continuous permanent or semi-permanent barrier that spans the entire work area, that is at least 4 feet in height, and is of sufficient strength to prevent a roadway worker from fouling the adjacent track.

**Lone Worker (RWP)** — An individual roadway worker that is not being afforded On-Track safety by another roadway worker, is not a member of a roadway work group, and is not engaged in a common task with another roadway worker.

**Minor Correction (RWP)** – Repairs of a minor nature, including but not limited to, welding, spiking, anchoring, hand tamping and joint bolt replacement using hand tools or handheld, hand supported, or hand guided power tools. The term does not include machine spiking, machine tamping, or any similarly distracting repair.

**Occupied Track (RWP)** – A track on which On-Track, self-propelled equipment or coupled equipment is authorized or permitted to be located while engaged in a common task with a roadway work group with at least one of the roadway workers on the ground.

**Qualified Roadway Worker (RWP)** — A status attained by an employee who has successfully completed the applicable portions of Norfolk Southern's Roadway Worker Protection training and has been authorized by the employer under these rules to perform the duties of a particular position or function.

**Roadway Maintenance Machine** — A device powered by any means of energy other than hand power that is being used on or near a railroad track for maintenance, repair, construction, or inspection of track, bridges, roadway, signal, communications, or electric traction systems. Roadway maintenance machines may have highway or rail wheels, or may be stationary.

**Roadway Maintenance Machines Equipped with A Crane** - Any roadway maintenance machine equipped with a crane or boom that can hoist, lower, and horizontally move a suspended load. *Added 4/1/17*

**Roadway Work Group** — Two or more roadway workers working together on a common task.

**Roadway Worker** — Any employee of a railroad or of a contractor to a railroad engaged in inspection, construction, maintenance, or repair of railroad track, bridges, roadway, signal and communication systems, electric traction systems, roadway facilities or roadway maintenance machinery, fouling a track or with the potential of fouling a track, or when working as flagmen or watchmen/lookout.

**Roadway worker in charge (RWIC)** - A roadway worker who is qualified under federal regulations to establish on-track safety for roadway work groups, and lone workers qualified under federal regulations to establish on-track safety for themselves. *Added 4/1/17*

(NOTE: Roadway Worker Protection rules will also apply to the operation of On-Track equipment if the Operator and/or occupants of the equipment are engaged in any of the foregoing work activities.)

**RWP Manual** - the entire set of on-track safety rules and instructions maintained together in one manual designed to prevent roadway workers from being struck by trains or other on-track equipment. These instructions include operating rules and other procedures concerning on-track safety protection and on-track safety measures. *Added 4/1/17*

**Train Approach Warning (RWP)** — A method of establishing On-Track safety by warning roadway workers of the approach of trains, engines, or other railroad equipment, in ample time for them to move to or remain in a place of safety.

**Watchman/Lookout (RWP)** — An employee who has been annually trained and qualified to provide warning to roadway workers of approaching trains or On-Track equipment.

**Working Limits (RWP)** — A segment of track with definite boundaries established in accordance with Rule 710, upon which trains, engines, or other railroad equipment may operate only as authorized by the roadway worker having control over that defined segment of track. Working limits may be established through “exclusive track occupancy” or “inaccessible track.”

**Rules in Effect** — The specific operating rule(s) that govern the use of main tracks designated by the Timetable.

**Safety-Related Employee** – any employee who:

- Is covered under the hours of service laws;
- Inspects, installs, constructs, repairs, or maintains track, roadbed, bridges, and signal and communication systems;
- Inspects, repairs, or maintains locomotives, passenger cars or freight cars, or other on-track equipment when such equipment is in service that constitutes a train movement;
- Determined that an on-track roadway maintenance machines or hi-rail vehicle may be used without repair of a non-complying condition;
- Directly instructs, mentors, inspects, or tests, as a primary duty, any person while that other person is engaged in a safety related task; or
- Is responsible for conducting periodic tests and inspections of safety-related employees.

**Siding** — An auxiliary track for meeting or passing trains, shown as a siding in the Timetable.

**Controlled Siding** — A siding equipped with controlled signals that authorize trains or engines to enter or leave the siding.

**Signaled Siding** — A siding with **Rule 261** in effect governing all train and engine movements on the siding.

**Signal Aspect** — The appearance of a fixed signal, which conveys an indication, as viewed either:

- (a) From the direction of an approaching train or engine.
- (b) On the cab signal display unit.

**Signal Indication** — The required action conveyed by the aspect of a signal.

**Special Instructions** — Instructions so captioned in the Timetable.

**Speeds:**

**Limited Speed** — For passenger trains, not exceeding 45 MPH; for freight trains, not exceeding 40 MPH.

**Maximum authorized speed** - The highest speed permitted for the movement of trains permanently established by Timetable or Operations Bulletin. Trains must be governed by temporary speed

restrictions and equipment speed restrictions if more restrictive than permanent speeds. *Added 4/1/17*

**Medium Speed** — A speed not exceeding 30 MPH.

**Restricted Speed** — A speed that will permit stopping within half the range of vision, short of train, engine, obstruction, railroad car, men or equipment fouling track, any signal requiring a stop, or any derail or switch lined improperly and looking out for a broken rail, but not exceeding:

- 20 MPH, or
- 15 MPH when diverting through any turnout or crossover governed by Conrail Signal indications

**Slow Speed** — A speed not exceeding 15 MPH.

**Speed Control** — A device on an engine that will cause a penalty brake application if the Engineer fails to reduce the train's speed to the speed required by the cab signal indication.

**Station** — A location designated in the Timetable by name.

**Switches:**

**Dual-Control Switch** — A power-operated switch that is also equipped for hand-throw operation.

**Electrically Locked Switch** — An electrical locking device applied to a hand-operated switch or derail.

**Power-Operated Switch** — A switch that is operated electrically or electro pneumatically. Such switches may or may not be equipped for hand-throw operation.

**Spring Switch** — A switch equipped with a spring mechanism arranged to restore the switch points to normal position after having been trailed through.

**Timetable** — A publication containing system and/or division instructions relating to operations.

**Track Authority** — Authorization to use controlled track, received in writing or copied and repeated at the direction of the Train Dispatcher using radio or other communication. Track Authority must be written on the prescribed form.



**Train** — An engine or more than one engine coupled, with or without cars, displaying a marker.

**Train Clearance** — Current operating instructions, including temporary speed restrictions and other restrictive conditions, issued over the signature of the Dispatcher. Special instructions will identify line segments on which Dispatcher's Bulletins will be used, as well as specific locations where originating trains must receive a copy.

**Yard** — A system of tracks other than main tracks or sidings used for making up trains and other purposes.

**Yard Access Crossing** — A private crossing at grade located within a rail yard that is open to unrestricted public access, or to persons other than railroad employees.

**Yard Engine** — An engine assigned to yard service.

**Yard Limits** — A portion of main track designated by Timetable. The limits are identified with "Yard Limit" signs.

# INDEX

<b>ATTENTION TO DUTY</b> .....	<b>11</b>
5. Electronic Devices .....	14
1. Job Safety Briefings .....	11
3. Napping.....	13
4. Performing Duties Safely.....	14
2. Prohibited Activities .....	12
<b>AUTOMATED PROCESS CONTROL HUMP YARDS</b> .....	<b>232</b>
875. Equipment Beyond the Skate Retarders.....	233
870. Humping.....	232
<b>BLUE SIGNAL PROTECTION</b> .....	<b>182</b>
657. Authority to Move Units on Engine Service Track .....	183
659. Blue Signal on a Remotely Controlled Switch .....	183
658. Blue Signal on Main Track .....	183
660. Blue Signal on Other Than Main Track .....	184
650. Blue Signal Protection .....	182
654. Blue Signals on a Controlling Unit .....	183
661. Blue Signals on Industry Tracks .....	186
653. Blue Signals Protecting Equipment .....	183
651. Display of Blue Signals .....	182
652. Emergency Repair Work .....	182
655. Entering an Engine Service Track .....	183
656. Moving Units on Engine Service Track .....	183
662. Protection Required in Connection with End-Of-Train Devices or Markers.....	186
663. Rolling Equipment under Blue Signal Protection.....	186
670. Utility Employees .....	187
<b>CAB SIGNAL SYSTEM</b> .....	<b>147</b>
369. Authorization for Movement in Rule 368 Territory.....	157
364. Cab Signal Aspect Flips .....	154
355. Cab Signal Aspects .....	147
359. Cab Signal Changes between Fixed Signals .....	151
367. Cab Signal Portion of Wayside Signaling Equipment Not Operative.....	154
366. Circumstances in Which Cab Signal Gives no Indication .....	154
358. Conformity between Cab Signals and Fixed Signals .....	150
361. Criteria for Determining Cab Signal Apparatus Failure .....	152
365. Engineer's Responsibility to Report on Forms .....	154
360. Movement with Inoperative Cab Signals .....	152
368. Movements in Territory Where Cab Signals are Used without Fixed Automatic Block Signals .....	155
357. Testing Cab Signal Apparatus .....	149
362. Train Dispatcher's Authorizations for Movement .....	153
363. Train Dispatcher's Responsibility for Recording Movements .....	153
356. Train Not Equipped with Cab Signal Apparatus .....	148
<b>COMMUNICATION</b> .....	<b>25</b>
54. Achieving Positive Radio Identification .....	30
57. Acknowledging Receipt of a Transmission.....	31
35. Communication Equipment Requirements – Exceptions .....	26
34. Communication Equipment Requirements – Lone Worker .....	25
31. Communication Equipment Requirements – Maintenance of Way Equipment.....	25
32. Communication Equipment Requirements – Maintenance of Way Work Gangs .....	25

33. Communication Equipment Requirements – Roadway Worker in Charge.....	25
30. Communication Equipment Requirements - Trains .....	25
55. Continuous Positive Radio Identification .....	31
59. Ending a Transmission – Response Expected .....	31
60. Ending a Transmission – Response Not Expected .....	31
40. Equipment Responsibilities .....	26
42. Federal Communications Commission (FCC) Requirements .....	27
36. General Instructions for the Use of Radios .....	26
53. Identifying a Mobile Station .....	30
52. Identifying a Radio Transmission .....	30
51. Initiating a Radio Transmission .....	30
48. Locomotive Radio Failure .....	28
46. Malfunctioning Radios .....	28
38. Radio Channels .....	26
50. Radio – Field Emergency Situations .....	29
47. Radio Removed From Service .....	28
39. Radio Transmission Restrictions .....	26
37. Radio Use .....	26
45. Radio Voice Test .....	28
58. Repeating Transmissions .....	31
49. Reporting Emergencies by Radio .....	28
41. Taxi and Relief Crews – Communication .....	27
56. Verification of Radio Contact .....	31
<b>DEFINITIONS .....</b>	<b>234</b>
<b>EMPLOYEE RESPONSIBILITIES .....</b>	<b>177</b>
600. Authority and Responsibilities; Yardmasters .....	177
633. Blocking Devices .....	181
610. Conductors – Authority and Responsibilities .....	178
622. Leaving the Engine Cab .....	179
621. Operating an Engine.....	179
631. Presence on Duty; Relief .....	180
620. Responsibilities; Engine Service Employees.....	179
630. Responsibilities; Train Dispatchers .....	180
612. Seating .....	178
632. Transfer Record .....	180
623. Use Caution; Exercise Care .....	179
624. Use of Sand .....	179
<b>GENERAL NOTICE .....</b>	<b>1</b>
<b>GENERAL RULES .....</b>	<b>2</b>
O. Acting as Pilot .....	8
N. Conductors, Locomotive Engineers, and Employees Seeking Initial Certification .....	8
P. Dispatcher Qualification .....	8
F. Documentation .....	3
G. Drugs and Alcohol .....	4
E. Operations Bulletins .....	3
D. Notification .....	3
M. Qualifications .....	6
I. Reporting Non-Compliance .....	5
J. Reporting Unusual Occurrences .....	5
K. Required Certification .....	6
L. Required Examinations .....	6

S. Riding Locomotives and Freight Trains .....	10
C. Rules, Bulletins, and Special Instructions.....	2
Q. RWIC and Equipment Operator Qualification .....	9
A. Standard Time.....	2
R. Tampering and Unauthorized Devices.....	9
H. Terms for Crewmembers .....	5
B. Watch Requirement.....	5
<b>HANDLING SWITCHES AND DERAILS.....</b>	<b>70</b>
194. Authority to Enter Main Track at a Hand-Operated Switch.....	74
200. Clearing Main Track .....	76
201. Clearing Main Track at Hand-Throw Switch .....	76
206. Corresponding Position .....	79
204. Crossover Switch Alignment .....	79
203. Crossover Switches .....	79
205. Crossover Switches in Correspondence .....	79
212. Derails: Location & Position .....	82
185. Double Checking Switch or Derail Position .....	71
192. Dual Control Switches .....	73
184. Engineering Department Operating Switches .....	70
188. Fouling or Entering a Track .....	72
183. Hand Operated Switches Equipped with Electric Locks .....	70
198. Leaving a Main Track Switch Open .....	76
186. Lining and Locking Switches and Derails after Use .....	71
191. Lining Main Track Switch – Employee Position.....	73
187. Operating Over a Switch .....	71
209. Operating Spring Switches by Hand .....	80
182. Operating Switches by Hand .....	70
195. Operation of Hand Throw Mainline Switches .....	75
213. Permanent Blue Signal Derails.....	82
190. Position of Main Track and Siding Switches .....	73
193. Power-Operated Switches .....	74
199. Reporting Clear of Main Track .....	76
181. Responsibilities; Hand Operated Switches and Derails .....	70
210. Restoring Spring Switches .....	80
211. Spring Switch Marker Lights .....	80
207. Spring Switches .....	80
208. Stopped on Spring Switches .....	80
202. Switch Position Awareness: Requirements for Hand-Operated Main Track Switches in Non-Signaled Territory and Rule 251 “Track Signaled in One Direction” .....	77
197. Switch Position Confirmation .....	76
189. Switches – Line of Road and Industry Tracks .....	72
<b>MANDATORY DIRECTIVES .....</b>	<b>158</b>
505. Acknowledging a Mandatory Directive .....	159
506. Acting upon a Mandatory Directive .....	160
521. Authority Form .....	162
552. Authorizing a Joint Track Authority .....	167
553. Clearing a Joint Track Authority .....	168
574. Clearing Authorized Limits.....	172
542. Conditional Reminders of Authorities Restricting Movement .....	166
543. Conditional Track Authorities – Rule 171 Territory.....	166
532. Conductor Not on Controlling Unit .....	164

541. Confirmation of Authorities Restricting Movement .....	166
502. Copying a Mandatory Directive .....	158
524. Designated Limits .....	162
523. Designation of Trains .....	162
575. Dispatcher Clearing Authority .....	172
535. Electronic Transmission .....	165
511. Exclusive Authority – Controlled Track .....	161
510. Exclusive Track Occupancy (ETO) .....	161
571. Expiration of Authority .....	171
570. Expiration Time .....	171
581. Filling out Forms in Advance .....	174
531. Giving “OK” Time .....	164
580. Improper Entries Discovered .....	174
500. Initiating a Mandatory Directive .....	158
540. Issuing Authorities Restricting Movement .....	166
522. Mandatory Directive Authority Form .....	162
525. Movement Authority .....	163
550. Occupying Same Limits .....	167
534. “OK” .....	165
576. OS’ing (Reporting Passed) .....	172
526. “Other Specific Instructions” .....	163
512. Precautions Issuing Authorities .....	161
513. Protecting Exclusive Authority .....	161
551. Protecting Joint or Overlapping Limits of Trains .....	167
561. Protecting Joint or Overlapping Limits – Roadway Workers or On-Track Equipment .....	169
560. Protecting Roadway Workers or On-Track Equipment .....	169
501. Receiving a Mandatory Directive .....	158
529. Receiving a Track Authority .....	164
533. Relaying Track Authority Information .....	165
572. Relieved During Tour .....	171
504. Repeating a Mandatory Directive .....	159
573. Reporting Clear .....	171
520. Requesting Authority .....	162
562. Requirements for Issuing Overlapping Limits to Roadway Workers or On-Track Equipment .....	169
563. Roadway Workers & Operators of On-Track Equipment – Do Not Foul Limits Ahead Of” .....	170
554. Subdividing Limits .....	168
503. Transmitting a Mandatory Directive .....	158
527. Transmitting Contents of an Authority Form .....	164
530. Verifying a Track Authority .....	164
507. Voiding a Mandatory Directive .....	160
577. Voiding a Track Authority .....	173
<b>MOVEMENT OF TRAINS AND ENGINES .....</b>	<b>40</b>
180. Acknowledging Slow Order Information In-Cab .....	69
126. Activation Failure .....	53
122. Adjacent Tracks at Crossings .....	51
123. Approaching Crossings with Automatic Warning Devices .....	51
100. Approaching the End of Two or More Tracks, Railroad Crossings At Grade, and Drawbridges .....	43
120. Cars not Headed by an Occupied Engine over a Highway – Rail Grade Crossing .....	50

121. Clearing Crossings .....	51
179. Communicating Speed of Slow Orders .....	69
172. Communicating Station Names .....	67
154. Conditions When a Visual Inspection is Not Required .....	62
178. Conductor's Responsibility – Approaching Slow Orders and Conditional Stop Signs .....	69
155. Consecutive Detector Stops .....	62
145. Defective Equipment Detectors .....	57
150. Dragging Equipment Detectors .....	60
110. Emergency Brake Application – Warning to Approaching Trains On Adjacent Tracks .....	46
176. Engineer Requirements at Meeting Points .....	68
141. Equipment with Defects .....	55
152. Failure Message Received .....	61
127. False / Partial Activation .....	53
98. Helper Service .....	42
151. High Car and Clearance Detectors .....	60
125. Highway – Rail Grade Crossing Warning System Malfunction .....	52
149. Hot Wheel Detectors .....	60
148. Hotbox Detectors .....	59
140. Inspecting Trains .....	55
93. Main Track Within Yard Limits .....	40
124. Manually Raising Crossing Gate Arms .....	52
97. Movement of Single Light Locomotive.....	41
129. Near Miss .....	54
153. No Message Received .....	61
171. Non-Signaled Main Track – Mandatory Directive Authorizes Movement .....	67
102. Permanent Signs .....	43
174. Positive ID at Meeting or Passing Points .....	68
99. Precautions against Unusual Conditions.....	42
101. Protection against Following Trains .....	43
177. Responsibility for Authorized Limits .....	68
94. Responsibility for Safety of the Train .....	41
112. Responsibility of the Train Dispatcher after an Emergency Brake Application .....	46
104. Restricted Equipment .....	45
96. Return Movement .....	41
115. Reverse Movements on Controlled Track .....	48
103. Safe Movement of Trains and Engines – Slow Order Conditions .....	44
142. Setting off Cars on Line-of-Road .....	56
95. Starting .....	41
105. Stopping on Bridges .....	45
156. Stress State Detectors .....	62
175. Switches at Meeting Points .....	68
128. Traffic at Crossings .....	54
116. Train Dispatcher Authorizing Reverse Movements .....	48
113. Train Inspection after an Emergency Brake Application .....	46
147. Train Inspection – Defect Message .....	58
146. Train Inspection – “No Defect” Message.....	58
111. Trains on Adjacent Tracks .....	46
<b>REMOTE CONTROL LOCOMOTIVES .....</b>	<b>226</b>
855. Daily Inspection Procedures (RCO) .....	229

856. Proper Handling and Securement of OCUs .....	230
857. Pullout Stopping Protection .....	231
853. Remote Control Areas .....	228
850. Remote Control Guidelines .....	226
854. Remote Control Zones .....	228
852. Securing Equipment (RCO).....	228
851. Setup and Testing (RCO) .....	227
<b>ROADWAY WORKER PROTECTION .....</b>	<b>189</b>
760. Adjacent Controlled Track .....	207
765. Adjacent Controlled Track “Job Briefing” .....	210
731. Authorization to pass a Conditional Stop Sign .....	196
727. Conditional Stop Sign Bulletin Item .....	195
734. Conditional Stop Sign Located at a Point or Time Not Designated by Form Y .....	197
735. Conditional Stop Sign Not Located at a Point or Time Designated by Form Y .....	197
726. Conditional Stop Signs Job Briefing .....	195
725. Conditional Stop Signs – Working Limits .....	195
751. Control of Working Limits .....	204
759. Employee Positioning and Communication when Using Train Approach Warning .....	206
732. Entering into Form Y Working Limits .....	197
721. Establishing Extent of Exclusive Track Occupancy Limits .....	193
741. Establishing Working Limits by Train Coordination .....	200
763. Exceptions to On-Track Safety for Adjacent Controlled Tracks .....	208
720. Exclusive Track Occupancy (RWP) .....	193
736. Form Y .....	198
745. Inaccessible Track.....	202
783. Individual Train Detection Place of Safety .....	212
781. Individual Train Detection Selection .....	211
737. Junctions and/or Switches Located Within Working Limits or Between the Sign and Conditional Stop Sign .....	198
784. Lone Worker Positioning .....	212
761. Movement on Adjacent Controlled Track .....	207
752. Movements of Trains and Engines Within Working Limits .....	204
753. Notification Before Releasing Working Limits .....	204
710. On-Track Procedures for Roadway Work Groups .....	192
780. On-Track Safety Procedures for Lone Workers .....	211
730. Placement of Conditional Stop Signs .....	196
785. Recording Individual Train Detection .....	212
743. Recording Train Coordination Working Limits .....	201
762. Resuming Work .....	208
733. Reverse Direction or Reverse Movement While Within Form Y Working Limits .....	197
764. Roadway Maintenance Machines Fouling Adjacent Tracks .....	210
702. Roadway Worker Duties .....	189
701. Roadway Worker Job Briefing .....	189
700. Roadway Worker Responsibilities .....	189
705. Roadway Worker Visibility .....	190
711. Roadway Workers Fouling a Track .....	192
747. Switch or Derail Tags .....	203
757. Train Approach Warning Notification and Attention .....	205
756. Train Approach Warning Provided by Watchmen / Lookouts .....	205
740. Train Coordination .....	200
742. Train Coordination Communication .....	200

704. Understanding Before a Lone Worker Fouls a Track .....190

703. Understanding Before Roadway Workers Foul a Track .....190

728. Use of Approach Signs .....195

729. Use of Conditional Stop Sign .....196

782. Use of Individual Train Detection .....211

758. Watchman / Lookout Equipment .....205

712. Work That May Shunt Track Circuits (RWP) .....192

754. Working Limits on Controlled Track .....204

746. Working Limits of Inaccessible Track .....202

755. Working Limits on Non-Controlled Track .....204

**SAFETY CRITICAL RULES..... 17**

27. Close Clearance .....24

21. Fouling a Track .....19

22. Fouling Equipment .....20

25. Occupying Roofs of Freight Cars .....24

20. Prohibited Acts .....17

24. Protection in Bowl (Classification) Tracks .....23

26. Riding Side of Equipment .....24

23. Single Engineer Procedures for Fouling Equipment.....22

**SIGNAL ASPECTS AND INDICATIONS..... 96**

288. Absent or Imperfectly Displayed Aspects or Erratic Signals .....106

277. Authorization to Pass a Stop Signal .....102

286. Automatic Block Signal Used in Non-ABS Territory .....105

285. Beginning and Ending of ABS Territory .....105

241. Communicating Block and Interlocking Signals .....96

244. Communicating Change in Cab Signal Aspect .....97

242. Conductor Communicating Signals .....96

243. Crewmembers on Trailing Units Communicating Signals .....97

281. Delayed / Stopped in a Block .....104

279. Entering Controlled Track between Signals .....103

300. General Requirements; Qualifying Features .....114

289. Improper Signal .....106

272. Lining Route and Clearing Signals .....100

299. Lining Signals in the Field during Code Fail .....111

301. Location of Signals .....114

297. Movement Authority during Suspension of the Signal System .....111

252. Movements against the Current of Traffic – Rule 251 “Track Signaled in  
One Direction” Territory .....98

282. Movements Stopped Near Controlled Signals .....104

284. Moving from Signaled to Non-Signaled Controlled Track .....104

283. Next Signal Governing .....104

302. Number Plates .....115

298. Operating Instructions during Suspension of the Signal System .....111

276. Passing a Stop Signal with Proper Authority .....101

240. Responsibilities; Movement of Trains and Engines on Signal Indication .....96

292. Rusty Rail .....108

290. Shunting – Track .....107

295. Signal and Switch Malfunction .....110

305 – 325. Signal Aspects and Indications – Conrail Signals.....117

326 – 339. Signal Aspects and Indications – Norfolk and Western Signals .....129

340 – 354. Signal Aspects and Indications – Norfolk Southern Railway Signals .....139

245. Signal Indication Information .....97



273. Signals Requiring a Stop .....	100
274. Stop Obstruction Banners .....	100
275. Stopped at a Stop Signal .....	100
296. Suspension of the Signal System.....	110
291. Testing Signals .....	107
294. Track Lights Left Behind Trains .....	109
293. Track Occupancy Lights .....	108
251. Track Signaled in One Direction – Signals Authorize.....	98
250. Tracks Designated in the Timetable.....	98
271. Track Signaled in Both Directions – Mandatory Directive Authorizes Movements.....	99
261. Track Signaled in Both Directions – Signals Authorize Movements .....	99
280. Train Delayed in Approach to Automatic Interlocking .....	103
287. Unexpected Signal Changes .....	105
278. Violating a Stop Signal .....	103
<b>SIGNALING EQUIPMENT .....</b>	<b>32</b>
78. All Auxiliary Lights Fail En Route .....	37
74. Auxiliary Lights .....	37
79. Auxiliary Lights When Employees are Mounting .....	37
66. Care and Use .....	32
72. Engine Bell .....	36
65. Equipment .....	32
82. Flashing Electric Markers .....	38
67. Fusees .....	32
69. Giving and Receiving Hand Signals .....	33
68. Hand Signals .....	33
70. Locomotive Horn Signals .....	34
71. Locomotive Horn Failure .....	35
73. Locomotive Headlights .....	36
84. Marker Examination Requirements.....	38
85. Marker for Light Engine or Engine on the Rear of a Train.....	39
77. One Pair of Auxiliary Lights Fail En Route .....	37
76. Operational Auxiliary Lights .....	37
75. Operative Auxiliary Lights .....	37
83. Red Reflectorized Disc or Red Flag Marker.....	38
81. Requirements for Markers .....	38
80. Situations to Turn Off Auxiliary Lights .....	37
<b>SHOVE MOVEMENTS.....</b>	<b>83</b>
221. Mechanical Department Responsibility – Shove Lights .....	87
217. Operating a Train from Other than Leading End .....	85
218. Shove Lights – Job Briefing .....	86
219. Shove Lights – Shove Movement .....	86
216. Shoving, Backing, or Pushing Movements .....	84
215. Shoving Equipment at Any Location .....	83
220. Yardmaster Responsibility – Shove Lights .....	87
<b>SWITCHING OPERATIONS.....</b>	<b>88</b>
238. Cars Being Loaded or Unloaded .....	94
223. Equipment Left Standing .....	88
225. Hand Brake Requirements .....	89
224. Hand Brakes .....	89
237. Mismatched Couplers .....	94
236. On Curves or In Switches .....	94

239. Open Doors on Equipment .....	95
233. Passenger Equipment, Camp Cars, Caboose, and Wheel Cars .....	93
230. Proper Understanding between Crews When Switching.....	92
234. Protection of Rail Equipment .....	94
231. Running or Flying Switches or Dropping Cars .....	92
228. Securement of Equipment .....	91
227. Securement of Key Trains .....	89
232. Switching Near Passenger Stations .....	93
229. Switching Operations.....	92
226. Testing Hand Brakes .....	89
235. Wheel Chocks .....	94
<b>USE AND OPERATION OF ON-TRACK EQUIPMENT .....</b>	<b>213</b>
821. Approaching Trains (OTE) .....	219
822. Drawbridges (OTE) .....	219
802. Equipment Inspection (OTE) .....	213
803. Flagging Equipment .....	213
811. Fouling a Railroad Crossing at Grade (OTE) .....	217
827. Fuel Tanks; Open Flames; Cooling Systems (OTE) .....	220
813. Highway Grade Crossings; Warning Devices (OTE) .....	217
809. Insulated On-Track Equipment .....	216
806. Joint Occupancy of Working Limits (OTE) .....	215
807. Movement in Yard Limits and Rule 251 Territory (OTE).....	216
817. Moving Against the Current of Traffic (OTE) .....	218
810. Non-Insulated On-Track Equipment .....	216
808. Non-Interlocked Railroad Crossing at Grade (OTE) .....	216
814. Operating with Caution (OTE) .....	217
820. Operation at Night (OTE) .....	219
829. Operation of FRA Track Geometry Car, Sperry Rail Test Cars, and Rail Grinders .....	221
818. Proper Spacing Between Rail Equipment .....	218
804. Protecting Work Locations (OTE) .....	214
840. Protection of Occupied Camp Cars .....	223
805. Protection on Controlled Track (OTE) .....	214
826. Pushing, Towing, Coupling Equipment .....	220
825. Rail Sweeps .....	220
824. Repairs to Equipment .....	220
842. Responsibilities of Camp Car Occupant/Supervisor .....	223
844. Responsibilities of Employees Controlling Remotely Controlled Switches (Camp Cars) .....	224
800. Responsibilities; On-Track Equipment .....	213
841. Restrictions (Camp Cars) .....	223
823. Riding Equipment; Adjustments .....	219
819. Securing On-Track Equipment .....	219
816. Shunting (OTE) .....	218
812. Speed of On-Track Equipment .....	217
828. Switch-Derail Position (OTE) .....	221
801. Use of On-Track Equipment .....	213
815. Vigilant Lookout; Conduct (OTE) .....	218
843. When Camp Cars are to be Moved .....	224
<b>WEATHER PRECAUTIONS .....</b>	<b>175</b>
590. Flash Flood Warning .....	175
591. High Wind Alerts .....	176



**TT-SYS**

**SYSTEM TIMETABLE**

**Timetable Number**

**1**

**EFFECTIVE JANUARY 1, 2015**

# TABLE OF CONTENTS

<b>GENERAL SPEED RESTRICTIONS (SP)</b> .....	<b>1</b>
SP-1. Speed Restrictions – Cars .....	1
SP-2. Speed Restrictions – Locomotives .....	1
SP-3. Speed Restrictions – Trains .....	2
SP-4. Speed Restrictions – Other Equipment .....	3
SP-5. Speed Restrictions – Sidings and Auxiliary Tracks .....	3
SP-6. Speed Restrictions – Flangers .....	4
SP-7. Speed Restrictions – Track .....	4
<b>EQUIPMENT RESTRICTIONS (EQ)</b> .....	<b>5</b>
EQ-1. Maximum Weight .....	5
EQ-2. Schnabel and High-Capacity Flat Cars .....	5
EQ-3. Jordan Spreaders .....	7
EQ-4. Snowplow – NW 590000 .....	7
EQ-5. Jet Snow Blowers .....	7
EQ-6. Scale Test Cars .....	7
EQ-7. Two-Unit Cars .....	8
EQ-8. GTTX or JTTX Cars .....	9
EQ-9. Train Placement of 5-Well Equipment .....	9
EQ-10. Double Stack Equipment .....	9
EQ-11. Blocks of Empty and Loaded Cars .....	10
EQ-12. Buffer Cars Between Multi-Level and Open-Top Cars .....	10
EQ-13. Excessive Height Multi-Levels .....	10
EQ-14. Excessive Dimension Equipment .....	10
EQ-15. Other Equipment Restrictions .....	12
EQ-16. Welded Rail Trains and Associated Equipment .....	12
EQ-17. Turnout Cars .....	15
EQ-18. Loaded Panel Switch Cars .....	15
EQ-19. Traction Motor Cars .....	15
EQ-20. Caboosees .....	15
EQ-21. Do Not Hump & Helper Restrictions .....	15
EQ-22. Equipment with Booms .....	16
EQ-23. Wrecked / Disabled Cars .....	16
EQ-24. Lumber Cars .....	16
EQ-25. Locomotive Cranes / Pile Drivers .....	17
EQ-26. FRA Track Geometry Cars .....	17
EQ-27. Scrap Metal Cars .....	18
EQ-28. Track Scales .....	18
EQ-29. GROX Equipment – Air Hose Configuration .....	18
EQ-30. Trains That Cannot Be Pushed .....	18
EQ-31. Hump Yard – Extra Heavy Loads .....	19
EQ-32. Protecting Passenger Trains .....	19

# TABLE OF CONTENTS (continued)

EQ-33. Movement of Cars on Government Bills of Lading .....	20
EQ-34. TBCX Flat Cars .....	20
<b>APPENDIX 1</b>	
Loaded Multi-Platform Stack/Spine Car Configurations .....	21
<b>APPENDIX 2</b>	
Hand-Held Air Gauge Accuracy Log. ....	22
<b>INDEX</b> .....	<b>23</b>

This page is intentionally left blank.







# SPEED RESTRICTIONS

## SP-1. Speed Restrictions – Cars

MAXIMUM SPEED

- (a) 40 or more empty multi-level cars unless moving in a solid multi-level train, or in a solid block on the rear of a mixed freight train.....25 MPH
  - (b) Short ore hopper cars (35’ or less): loaded.....30 MPH  
empty.....35 MPH
  - (c) Empty top gons and empty open-top hoppers (foreign or system) unless handled in solid empty unit train, and empty bulkhead flats or empty woodracks (foreign or system) .....45 MPH
- EXCEPTION:**  
Restriction does not apply:
1. If car is shown on train consist, but is not identified as restricted equipment. (Top gons, open-top hoppers, bulkhead flats and woodracks equipped with constant contact side bearings are not restricted and will not be identified by the computer as restricted equipment.)
  2. To center beam flat cars.
- (d) Empty log cars in series:  
NS 111500–NS 111538 and SOU 118039.....45 MPH
  - (e) Loaded coil steel cars in series:  
NS 609996–NS 610210 and NS 659050–NS 659068.....40 MPH

**Revised 7/16/15**

## SP-2. Speed Restrictions – Locomotives

- Single light locomotive .....30 MPH
- Locomotive not equipped with event recorder when operated as a single unit or as a lead unit.....30 MPH
- All steam locomotives .....40 MPH
- All other light locomotive consists of two or more units.....50 MPH

**NOTE:** Road Locomotives must not be operated through class yard retarders.

### SP-3. Speed Restrictions – Trains

MAXIMUM  
SPEED

Passenger Trains .....	79 MPH
Trains consisting entirely of, or a combination of, Triple Crown, Intermodal (TOFC/COFC) or Multi-Level equipment .....	60 MPH
Intermodal or Multi-Level trains handling: Loaded or empty automotive frame flat cars.....	60 MPH
Loaded or empty Mechanical Refrigerator Cars (Super Reefers).....	60 MPH

**EXCEPTION:** Certain Mechanical Refrigerator Cars (Super Reefers) are restricted. These cars will be identified as restricted on the wheel report with “50 MPH SPEED RESTRICTION WHEN EMPTY” or “50 MPH SPEED RESTRICTION”

Key Trains .....	50 MPH
------------------	--------

**EXCEPTION:** Key Trains carrying 20 or more loaded tank cars of Class 3 Flammable Liquids or Crude Oil are restricted to 40 MPH within High Threat Urban Areas (HTUA).

When applicable, the restriction will be indicated on the Wheel Report as follows:

**“40 MPH SPEED RESTRICTION THROUGH HTUAs”.**

Crews picking up Class 3 Flammable Liquids or Crude Oil en route should refer to their paper work to determine if these additional cars will require their train to be restricted, or contact OSS for assistance.

High Threat Urban Areas are identified by milepost limits in Division Timetables or by Operations Bulletins.

All other trains.....	50 MPH
-----------------------	--------

#### **Jointed Rail**

When freight trains handling one or more loaded cars are operated on jointed rail, the Engineer will avoid prolonged operation in speed range of 16 to 21 MPH. If speed cannot be maintained above 21 MPH, speed must be reduced to 15 MPH.

*Revised 8/16/17*

## **SP-4. Speed Restrictions – Other Equipment**

**MAXIMUM  
SPEED**

Shoving movements with caboose on leading end.....	30 MPH
Shoving movements with NS Geometry Car (NS 31, NS 33, NS 34, or NS 35) on leading end .....	25 MPH
Snowplow — NW 590000, when plowing (see EQ-4)....	25 MPH
Locomotive Cranes/Pile Drivers (see EQ-25) .....	25 MPH
2-axle Scale Test cars (see EQ-6) .....	30 MPH
Single unit of self-propelled work equipment that is designed to shunt track circuits (i.e. Sperry Rail Test car, Loram rail grinder, and ballast cleaner).....	30 MPH
Lucky Loader, NW 591006 loaded on gon NW 590901.....	35 MPH
Jordan Spreaders (see EQ-3) .....	40 MPH
Mulching Brushcutters Nos. NS 992700 — NS 992702.....	45 MPH
Derricks .....	45 MPH

*Revised 7/21/16*

## **SP-5. Speed Restrictions – Sidings and Auxiliary Tracks**

- (a) A train or engine must not exceed the maximum speed authorized in the Timetable. Speed restrictions shown in Timetables, bulletins, by speed limit signs, or by any other method must be observed.
- (b) Except where a different speed is authorized by signal indication, Timetable, or Special Instructions:
1. Sidings.....Restricted Speed not exceeding: 15 MPH
  2. All tracks other than the main track and sidings .....
  3. Movements diverting through  
turnouts or crossovers.....
  4. Engine servicing and car  
Shop repair tracks .....

## **SP-6. Speed Restrictions – Flangers**

- (a)** When handled behind locomotive, flanger must not exceed 30 MPH.
- (b)** When working, flanger must not exceed 5 MPH while:
  1. Passing station platforms.
  2. Passing over grade crossings.
  3. Passing equipment on adjacent tracks.
  4. Backing up.

## **SP-7. Speed Restrictions – Track**

FRA Excepted Track will be designated by Timetable. Movement on FRA Excepted Track:

- (a)** Must not exceed 10 MPH.
- (b)** Must not contain more than 5 cars that require Hazardous Material placards.
- (c)** Are prohibited for occupied passenger trains.

# EQUIPMENT RESTRICTIONS

## EQ-1. Maximum Weight

Cars having a combined weight of car and lading in excess of 286,000 lbs. must not be handled unless authorized by the Division Timetable.

## EQ-2. Schnabel and High-Capacity Flat Cars

(a) Restrictions for “schnabel” and other high-capacity flat cars having 8-axles or more:

1. Except where further restricted, speed must not exceed that indicated below:

Number of Axles	Maximum Speeds	
	Loaded	Empty
8 to 15	45 MPH	No Restrictions
16 or more and 12-axle APWX 1004	25 MPH	45 MPH
36 (CEBX 800)	15 MPH	25 MPH

2. When loaded, APWX 1004 (12-axles) and all cars having 16-axles or more must be handled in a special train of no more than 10 cars.

3. Loaded cars having 12-axles or more, when not moving in special train, must be handled at the head end of a train, and train length must not exceed 100 cars. Loaded cars must be accompanied by sufficient cars that may be used as brake cars in the event it becomes necessary to set out a loaded car between terminals and when securing cars in yards, terminals or sidings.

4. In addition to the above restrictions, the cars listed below must not be placed in trains requiring pusher service, humped, or flat switched with motive power detached. When moving empty, these cars must be handled on rear end of train, properly locked and secured. Switching moves must be kept to a minimum.

(b) Cars with 10-axles or more, either loaded or empty, must not be forwarded in a train without permission of the Chief Dispatcher.

CAR IDENTITY	NO. AXLES	CAR IDENTITY	NO. AXLES
ABWX 20002	12	GEX 40010	20
APWX 1004	12	GEX 80000	16
BBCX 1000	20	GEX 80002	16
CEBX 100	12	GEX 80003	20
CEBX 101	12	GPUX 100	12
CEBX 800	36	HEPX 200	20
CPOX 820	20	KWUX 10	20
DODX 39898	8	KWUX 102	22
DODX 39899	8	LNAL 200	12
ETMX 1001	18	PTDX 204	12
EXEX 1016	12	PTDX 201	14
GEGX 21154	16	PTDX 202	20
GEGX 21155	16	PTDX 203	14
GEX 40013	12	WECX 101	20
GEX 40017	12	WECX 301	22
GEX 40018	12		

- (c) Transformers, rotors, circuit breakers, or similar electrical equipment with net weight exceeding 200,000 lbs., loaded on a well, depressed, or flat car must be handled on or near the head end of trains except on locals. When these loads are designated to move on locals or high-wide specials, they will be positioned as instructed by the Clearance Department.
- (d) Loads with waybill having “high value” sticker, transformers, rotors, circuit breakers, or similar electrical equipment loaded on a well, depressed, or flat car will not be humped or permitted to roll free. They will be shoved to a coupling with motive power attached. Cars being coupled to such equipment will be handled in the same manner.

Trains handling any of the aforementioned equipment must not be pushed with more than the equivalent of 12 conventional (non-high-adhesion) powered axles.

### **EQ-3. Jordan Spreaders**

**(a) Movement in trains:**

1. Must not exceed 40 MPH.
2. Must be handled next to and ahead of caboose or on rear of train with “B” end trailing so that side spreaders, hinged near the “A” end of the car, are in the trailing position.
3. Must have swinging or rotating mechanism properly secured.

**(b) Movement in yards:**

1. Must not be moved through retarders due to insufficient clearance.
2. Must not be:
  - cut off in motion
  - struck by a free-rolling car
  - coupled into with more force than needed to make the coupling
3. While working, care must be taken to avoid contact with over- head or side obstructions.

### **EQ-5. Jet Snow Blowers**

Jet Snow Blowers loaded on flat cars must not be humped or flat switched with motive power detached.

### **EQ-6. Scale Test Cars**

**(a) 2-axle Scale Test Cars :**

1. Must move only on authority of the Chief Dispatcher.
2. Must be handled as second car ahead of rear car of train or caboose.
3. Must not be coupled to a car exceeding 55’ 00” in length.
4. Must not exceed 30 MPH.
5. Must not be humped.

**(b) 4-axle Scale Test Cars must not be humped. If 4-axle Scale Test Cars are destined to a hump yard, they should be**

moved as the head or rear car in the train or in an established “Do Not Hump” block.

(c) Scale Monitor Cars have no special restrictions.

### **EQ-7. Two-Unit Cars**

The following restrictions are applicable to:

- all two-unit TTEX cars
- two-unit RTTX cars in the series 165200 to 165552

(a) Must not be humped or flat switched with motive power detached except to a clear track.

(b) Empty cars or cars carrying 1 loaded or 1 empty trailer at 1 outer loading position must be handled per the following restrictions:

1. Trailing tonnage is restricted to 4,000 tons except in Distributed Power (DP) trains. Yard shove movements are restricted to 4,000 tons and must not exceed 12 powered conventional or 10 powered high-adhesion axles.
2. Car must not be handled in the first 10 cars ahead of Distributed Power (DP) units or rear-end helpers. Helper units must not exceed 12 powered conventional or 10 powered high-adhesion axles.
3. Locomotive amperage must be limited to 400 AMPS in dynamic braking while these cars are traversing turnouts or crossovers restricted to 25 MPH or less and while within terminal limits.

**EXCEPTION:** Cars having 3 loaded trailers or cars having empty or loaded trailers at both outer loading positions may be handled without restrictions.

### **EQ-8. GTTX or JTTX Cars**

Blocks of 10 or more empty GTTX or JTTX cars, when being moved in Distributed Power (DP) trains will be handled on the rear only behind the DP units.

Blocks of 20 or more empty GTTX or JTTX cars must be handled on the rear of non-Distributed Power trains.

### **EQ-9. Train Placement of 5-Well Equipment**



When loaded articulated 5-well double-stack equipment is located behind blocks of 89' flat cars and/or multi-level equipment with end-of-car cushioning device, to prevent increased buff forces requires good judgment in train handling procedures.

When building trains at terminals or receiving trains in interchange, special consideration must be given to train make-up containing this equipment.

When practicable, such equipment must be handled in the head 25 % of the consist.

These instructions do not apply to trains made up entirely of double-stack equipment.

### **EQ-10. Double Stack Equipment**

The Conductor and Engineer must determine if their train contains double-stack equipment prior to departure from originating terminal or crew change point. If the trains consist includes double-stack equipment, the Conductor or Engineer must notify the Train Dispatcher prior to departure. At run through crew change points, the crew being relieved will advise the relieving crew of the presence of double-stack cars in the train. On line- of-road, when a relief crew takes over a train with double-stack equipment, the Conductor must ensure the Train Dispatcher is notified of the equipment prior to departure.

When setting off or picking up double-stack cars on line-of-road, the Conductor must ensure the Train Dispatcher is notified of the double-stack pick up/set off before departing the station.

Before entering yards (even if an approved double-stack route) Conductor must ensure Yardmaster or Terminal Trainmaster is advised of the existence of double-stack cars in their train consist.

When necessary to set off or pick up a stack car account bad order status or otherwise, crewmembers are responsible to ensure clearance from over- head wires, cables, load docks, roof overhangs or any other obstructions above or adjacent to auxiliary track being used.

## **EQ-11. Blocks of Empty and Loaded Cars**

- (a) Blocks of Empty Cars** — Blocks of 30 or more empty cars must be handled on the rear of trains whenever practicable.
- (b) Blocks of Loaded Cars** — Blocks of 30 or more loaded cars of coal, grain, phosphate, rock, sand, sulfur or similar bulk commodities must be handled on the head of trains next to and behind locomotives whenever practicable.

## **EQ-12. Buffer Cars between Multi-Level & Open-Top Cars**

Loaded multi-level cars must not be placed for movement in trains behind open-top hopper cars or gondolas loaded with stone, gravel, sand, lime, coal, or soda ash except when separated by 10 buffer cars.

## **EQ-13. Excessive Height Multi-Levels**

Multi-level auto racks 20'2" high are excessive dimension cars (loaded or empty) and must be handled in accordance with high-wide clearance message. Before handling these cars on other than main tracks or sidings, it must be determined adequate clearance exists.

## **EQ-14. Excessive Dimension Equipment**

- (a)** All high and wide shipments must have copy of clearance file attached to regular waybill, and movements must be made in strict compliance with clearance file information.

Conductors on trains handling high and/or wide shipments will verify car initials and numbers with waybills and clearance files. Conductors will also verify route of each car by comparing route on waybill with Restricted Route as shown on Clearance File. Restricted Route will be more detailed. If any discrepancy exists, Conductor will notify the Chief Dispatcher by the quickest available means of communication and will not move the shipment until properly authorized.

The safe and proper handling of high and wide shipments requires strict compliance with instructions contained in the clearance file by train and engine crews and Train Dispatchers. The Engineer and Conductor on through, local, or high-wide trains must each have a copy of the clearance restriction file.

When handling more than one such shipment, Chief Dispatchers will determine the most restrictive of all shipments, and extra copies of this file will be furnished with the Train Clearance to both Engineer and Conductor.

Train Dispatchers, with the assistance of train and engine crews, will establish meeting and passing points in accordance with clearance files of all trains to be met or passed.

Train and engine crews will be responsible for passing standing cars on adjacent side, industrial, and yard tracks in accordance with clearance file restrictions.

Trains meeting or passing another train with high and wide shipments must comply with instructions received from the Train Dispatcher.

When trains handling high and wide shipments and/or triple loads go into emergency for any reason, in addition to inspecting their entire train, all high and wide loads and/or triple loads must be inspected to determine if loads or cars have been damaged or if loads have shifted. Train crews will advise Train Dispatcher of findings.

At stations where no Mechanical personnel are on duty and NS crews pull interchange from foreign railroads, inspection of cars for defects in accordance with **NS-1 Rule C-100** is required. Crew members will also make an inspection of open-top loads to determine the possibility of loads being excessive dimensional loads.

If there is any doubt regarding load being an excessive dimensional shipment, the Chief Dispatcher should be notified immediately to determine if shipment is, in fact, an excessive dimensional shipment requiring a clearance file. The shipment must not be moved until appropriate clearance file or proper authority is received.

If there is no clearance file available, the car should not be placed in train before a mechanical inspection is made to determine if the car is an excessive dimensional shipment. Before departing, Conductors on all outbound trains must check their consist. If high and wide shipments are shown on the consist, the Conductor must contact the proper authority before departing in order that clearances can be

checked prior to moving the train. On transfer movements departing yards, if cut of cars contains high and wide shipments this information will be shown on the “list.” The Conductor on outbound transfer cuts must also contact the Yardmaster or other designated employee to ensure that high and wide shipments have been cleared before departing.

- (b) Before handling excessive dimension equipment on other than main tracks or sidings, it must be determined that adequate clearance exists.

Oversize shipments must not be left on any track adjacent to the main track or sidings unless authorized by the Chief Dispatcher.

### **EQ-15. Other Equipment Restrictions**

- (a) Backhoes specially designed to unload crossties from gondolas constitute an excessive dimension car (13' 1" wide) when mounted on top of a gondola.

To ensure the safety of work trains as well as movements subject to passing on adjacent track(s), the following precautions must be taken when the backhoe is mounted on top of the car:

1. Equipment must be kept under observation with particular care being taken to avoid contact with side structures or obstructions.
2. Protection must be provided for movements on adjacent track(s).

- (b) Roller bearing equipped cars with converted friction bearing side frames are prohibited in interchange. Cars with converted friction bearing side frames must not be placed for loading. Cars found with converted friction bearing side frames must be turned over to the Mechanical Department for disposition.

### **EQ-16. Welded Rail Trains and Associated Equipment**

- (a) 2 loaded rail trains, or 1 loaded and 1 empty rail train, may be handled as 1 movement. When loaded and empty rail trains are handled together, the empty train must be on the rear.

Empty rail trains may be handled on the rear of revenue freight trains excluding those designated as corporate trains. If pusher service is required, the pusher must be placed ahead of the empty rail equipment.

Rail laying, T&S, and associated equipment may be handled on a loaded rail train but must be handled on the rear end only. Rail trains are permanently coupled together by having an approved locking device inserted in the uncoupling lever mechanism and secured with a bolt. These cars are not to be separated. In the event of a bad order car, the entire train must be set off until repairs are made.

Crewmembers taking charge of a loaded welded rail train will inspect it to determine that the uncoupling lever mechanism locks are in place on each car before moving the train except when relieving a crew that has previously handled the train, or when notified by the proper authority, the securement between the cars has been checked. This paragraph does not apply to a rail train originating in Atlanta, GA.

Cars coupled together and equipped to pick up and to unload strands of welded or bolted rail are not to be separated due to the possibility of damage to the hydraulic hose connection between the cars.

Loaded rail trains must not be originated from any crew change point without first being inspected and approved for movement by Maintenance of Way forces.

In the event of bad ordering any rail train and associated equipment, the Chief Dispatcher must notify Rail Welding Plant in Atlanta, GA.

Rail trains and associated equipment must not be handled without air on the trains and all other NS Rules applying to train air brakes and service reductions apply when handling these trains.

Welded rail trains handled on grades must not be separated from engine unless accompanied by a sufficient number of cars with effective hand brakes to secure the train.

**(b) Unloading Welded Rail at Railroad Crossing at Grade or Interlocked Junction**

Before a rail train unloads rail within the limits of a railroad crossing at grade or interlocked junction, protection as

prescribed below must be established and maintained to ensure that a crossline or conflicting movement will not enter the limits until the rail is clear of affected routes:

1. At controlled interlocking or at a junction equipped with power operated switch:  
Secure time and working limits.
2. At locations where the home signal for crossline or conflicting route is controlled by a Foreign Line railroad: Communication must be established with the Foreign Line Train Dispatcher and ensure positive protection has been established and will be maintained against Foreign Line movements until affected track section is reported clear by the employee who requested protection.
3. At an automatic interlocking or non-interlocked railroad crossing at grade:  
Cross line protection must be provided.

**(c) Uncoupling of NS-owned Rail Equipment**

Uncoupling of NS-owned flat cars operated solely in Rail Train service within the NS rail system is the responsibility of the Mechanical Department.

1. Uncoupling shall be performed under Blue Signal Protection and only by designated mechanical personnel. Prior to uncoupling any car, the uncoupling lever of that car shall be reattached.
2. Uncoupling levers may be removed from both ends of flat cars except cars at each end of a Rail Train consist must be equipped with an uncoupling lever at the end of the car to which other equipment may couple.
3. At each location where an uncoupling lever is removed, a car shall have the appropriate Association of American Railroads (AAR) approved coupler blocked, pinned, and locked to prevent the coupler from unintentionally uncoupling.
4. At each location where an uncoupling lever is removed, a car shall be stenciled with the words “CONTACT MECHANICAL DEPARTMENT TO COUPLE / UNCOUPLE” in letters of contrasting color to the car and at least 2 inches high.

## EQ-17. Turnout Cars

The following turnout car sets loaded or empty are **not to be separated when in transit**. If one of the cars is bad ordered both cars must be set off. If the cars are bad ordered because of mechanical problems, the Division Manager of Mechanical Operations' Office for the division must notify the Roanoke Material Yard, Roanoke, VA.

**Set Numbers:** (2 cars per set )

991001 – 991021

991007 – 991027

991002 – 991022

991008 – 991028

991003 – 991023

991009 – 991029

991004 – 991024

991010 – 991030

991005 – 991025

991011 – 991031

SOU 991006 – 991026

## EQ-18. Loaded Panel Switch Cars

Loaded panel switch cars must not be humped or cut off to roll free. They must be shoved to a coupling.

## EQ-19. Traction Motor Cars

Loaded traction motor cars and loaded truck cars must not be humped except when they are humped to a clear track.

## EQ-20. Cabooses

- (a) Cabooses will be handled on rear of trains unless otherwise authorized by the General Manager.
- (b) Must not be subjected to pusher or helper service.
- (c) Cabooses left unoccupied/unattended on line-of-road for any reason (i.e., switching, inspecting train, etc.) must be locked to protect personal and company property.

## EQ-21. Do Not Hump & Helper Restrictions

- (a) The following cars, loaded or empty, must not be humped or flat switched with motive power detached except to a clear track:
  1. Single or multiple-unit double-stack cars.
  2. Articulated single platform (SPINE) cars.
  3. Drawbar connected rapid discharge cars.
  4. Articulated or permanently coupled cars.
- (b) Double-stack cars must not be moved over hump retarders unless it is known there is proper clearance.

- (c) Whenever practicable, articulated cars and cars with slackless drawbars should be placed ahead of cars with conventional draft gears, which in turn should be placed ahead of cars with end-of-car cushion units.
- (d) Trains handling any of the aforementioned equipment must not be pushed with more than the equivalent of 12 conventional (non-high-adhesion) powered axles.

#### **EQ-22. Equipment with Booms**

A crane or other machine equipped with a boom, even if boom is detached, loaded on open-top car or moving on its own wheels must not be handled in through trains unless the boom end is trailing. It may be handled in local freight and work trains with boom forward when properly anchored.

**EXCEPTION:** Cranes and military equipment loaded on open-top cars may be handled in any train with boom or rotating part forward provided it is properly anchored with visible securement and does not overhang the end of the car.

#### **EQ-23. Wrecked / Disabled Cars**

Movement of wreck-damaged or disabled rail cars or parts of such cars loaded on flat cars or in open-top cars, and lading extends above or beyond the car sides, must be confined to locals, shifters, work, or wreck trains.

Authorization for movement in other trains must be secured from Transportation Clearance Department for each individual car.

Before such equipment is handled in any train, a Mechanical Department employee must inspect it and will authorize its movement and designate any speed restriction required for its safe handling.

#### **EQ-24. Lumber Cars**

Center partition lumber cars, foreign or system, must not be moved when cars are partially unloaded. These cars must not be pulled from an industry or moved without tie down cables being secured. Loading and unloading instructions and warnings not to move car without cables secured are stenciled on these cars at several locations.



## **EQ-25. Locomotive Cranes / Pile Drivers**

- (a) Locomotive cranes and pile drivers may be operated on all main and passing tracks.
- (b) Locomotive cranes, with or without attached boom idler car, must not be moved over humps or through retarders when being operated under their own power. Retarders must not be set up while such equipment is in the retarders.
- (c) Pile drivers must not be moved through retarders under any circumstances due to insufficient clearance. When pile drivers are placed in one of the classification tracks, they must be handled in the same manner as explosive cars.
- (d) Locomotive cranes and pile drivers while working must avoid contact with overhead or side obstructions.

## **EQ-26. FRA Track Geometry Cars**

- (a) Except where further restricted, speed of FRA Track Geometry Cars must not exceed:
  - Self-propelled or handled with a single locomotive.....30 MPH
  - When handled in special train service with two or more locomotives, or with two or more Geometry cars .....60 MPH

When handled in:

- Freight or non-revenue trains .....50 MPH
- Intermodal trains .....60 MPH
- Passenger trains .....79 MPH

(b) FRA Track Geometry Cars must:

1. Move only on authority of the Chief Dispatcher.
2. Not be subjected to pusher or helper service.
3. Not be humped or switched with locomotives detached.
4. Be handled with air hoses coupled and air cut in.
5. Not have more than 1500 trailing tons

## **EQ-27. Scrap Metal Cars**

Employees must not pull or accept from industry any gondolas, or other open top cars, loaded with scrap metal that extends above the top of the car sides or ends of the car.

## **EQ-28. Track Scales**

Where track scales have dead rails:

- (a) Engines must not be operated over live rails.
- (b) Cars must not be moved over live rails except when weighing operations are being performed.

## **EQ-29. GROX Equipment – Air Hose Configuration**

- (a) Any train containing GROX rapid dump hoppers must have the following test performed prior to departing the initial terminal or any location where train line continuity has been disturbed:

The Engineer must make a 25 lb. brake pipe reduction and a corresponding reduction must be observed by use of the end-of-train device. If the end-of-train device is defective or missing, an air gauge must be connected to the brake pipe at the rear of the train to confirm that brake pipe pressure at the rear corresponds to the Engineer's reduction.

- (b) On the "A" end of cars with GROX markings, the train line hose is on the left of the coupler, and the door dump line hose is on the right of the coupler.
- (c) On the "B" end of these cars, the door dump line hose is on the left of the coupler and the train line hose is on the right of the coupler. The glad hands on both the train line and door dump hoses are the same size and configuration.

All employees are to use extreme caution when coupling these hoses to ensure the correct connections are made. Afterwards, a brake test must be performed in accordance with all applicable rules and instructions.

## **EQ-30. Trains That Cannot Be Pushed**

The Train Dispatcher must be notified of trains that cannot be pushed.

## EQ-32. Protecting Passenger Trains

### (a) Passenger Train Movements

The Train Dispatcher must maintain at least 1 unoccupied block between non-passenger trains and occupied:

- Passenger trains
- Steam or Office Car Specials
- Employee/Passenger Excursions
- Operation Lifesaver trains

### (b) EXCEPTIONS:

**Following Movements** — following movements may be authorized to occupy the adjacent block when protected as follows:

1. The Train Dispatcher must notify the Engineer of the following train.
2. When notified, the following train must not occupy the same block with the train ahead. Trains receiving a Restricted signal indicating a train is ahead in the block must stop short of the signal until a more favorable signal is received or the Train Dispatcher authorizes movement.

**Train Meets** — during train meets, a train may be authorized to occupy the adjacent block provided the opposing train is stopped and the Engineer has confirmed that their train will remain stopped until the train has passed.

**Emergencies** — during emergencies, trains may be authorized to occupy the same or overlapping limits with a passenger train provided all train movements are made at Restricted Speed within the overlapping limits.

**Other** — these restrictions do not apply to:

1. Passenger trains operating on the Chicago Line.
2. Passenger trains, Steam, Office Car Specials, Employee/Passenger Excursions, or Operation Lifesaver trains switching at terminals.

3. Trains equipped with operative cab signals when operating in Cab Signal territory.

### **EQ-33. Movement of Cars on Government Bills of Lading**

When cars moving on Government bills of lading annotated:

AS — ARMED GUARD SERVICE  
DC — DOD CONSTANT SURVEILLANCE  
TK — TANK SURVEILLANCE SERVICE  
RS — RAIL SURVEILLANCE SERVICE

are set off between terminals other than at final destination, seals must be inspected and seal numbers recorded on the waybill. Also, the Chief Dispatcher must be notified by the quickest available means of communication and furnished the car initials, number, location of set off, and seal numbers.

Any exceptions such as broken or missing seals must be reported in the same manner. Chief Dispatcher must immediately notify NS Police Department.

### **EQ-34. TBCX Flat Cars**

Employees are prohibited from mounting, dismounting or riding cars in series TBCX 76702 through TBCX 76710 which are modified flat cars containing a covered housing for transporting aircraft parts.

If necessary to set these cars out, another car with an operating hand brake must be set out with it.

# APPENDIX 1

## **LOADED MULTI-PLATFORM STACK/SPINE CAR CONFIGURATIONS**

Shown below are examples of container/trailer loading configurations that would be considered a loaded car. This applies to both stack and spine cars. The containers/trailers can be loaded or empty. (The configurations shown below are in addition to all platforms being loaded.)

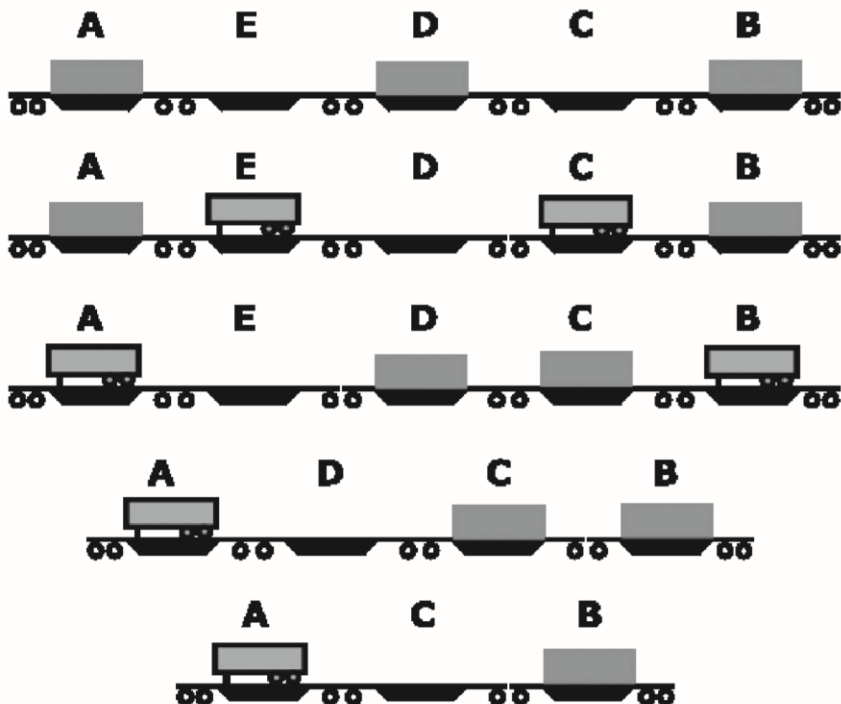



# INDEX

## B

EQ-11. Blocks of Empty and Loaded Cars .....	10
EQ-12. Buffer Cars Between Multi-Level and Open-Top Cars .....	10

## C

EQ-20. Cabooses .....	15
-----------------------	----

## D

EQ-21. Do Not Hump & Helper Restrictions .....	15
EQ-10. Double Stack Equipment .....	9

## E

EQ-22. Equipment with Booms .....	16
EQ-13. Excessive Height Multi-Levels .....	10
EQ-14. Excessive Dimension Equipment .....	10

## F

EQ-26. FRA Track Geometry Cars .....	17
--------------------------------------	----

## G

EQ-29. GROX Equipment – Air Hose Configuration .....	18
EQ-8. GTTX or JTTX Cars .....	9

## H

EQ-31. Hump Yard – Extra Heavy Loads .....	19
--	----

## J

EQ-5. Jet Snow Blowers .....	7
EQ-3. Jordan Spreaders .....	7

## L

EQ-18. Loaded Panel Switch Cars .....	15
EQ-25. Locomotive Cranes / Pile Driver .....	17
EQ-24. Lumber Cars .....	16

## M

EQ-1. Maximum Weight .....	5
EQ-33. Movement of Cars on Government Bills of Lading .....	20

## O

EQ-15. Other Equipment Restrictions .....	12
---	----

## P

EQ-32. Protecting Passenger Trains .....	19
--	----

## S

EQ-6. Scale Test Cars .....	7
EQ-2. Schnabel and High-Capacity Flat Cars.....	5

EQ-27. Scrap Metal Cars .....	18
EQ-4. Snowplow – NW 590000 .....	7
SP-1. Speed Restrictions – Cars.....	1
SP-6. Speed Restrictions – Flangers.....	4
SP-2. Speed Restrictions – Locomotives.....	1
SP-4. Speed Restrictions – Other Equipment.....	3
SP-5. Speed Restrictions – Sidings and Auxiliary Tracks.....	3
SP-7. Speed Restrictions – Track.....	4
SP-3. Speed Restrictions – Trains.....	2

**T**

EQ-34. TBCX Flat Cars .....	20
EQ-28. Track Scales .....	18
EQ-19. Traction Motor Cars .....	15
EQ-9. Train Placement of 5-Well Equipment .....	9
EQ-30. Trains That Cannot Be Pushed .....	18
EQ-17. Turnout Cars .....	15
EQ-7. Two-Unit Cars .....	8

**W**

EQ.16. Welded Rail Trains and Associated Equipment .....	12
EQ.23. Wrecked / Disabled Cars .....	1





